

Reimbursing Consumers' Switching Costs in Network and Non-network Industries*

Jiawei Chen Michael Sacks
University of California, Irvine Clarkson University

July 14, 2023

Abstract

To analyze how firms' policies to reimburse consumer switching costs affect prices, market structure, and welfare, we develop a dynamic duopoly model with network effects, switching costs, and switching cost reimbursement. We find that each firm's reimbursement strategy is nonmonotonic in its installed base. While nonmonotonic, the firm with the greater installed base always reimburses more of the switching cost than its smaller competitor, allowing the firm that obtains an early advantage to dominate the market. Consumers benefit from the reimbursement, while producers only benefit in network industries when network effects are large; otherwise, the reimbursement induces a prisoner's dilemma.

JEL Classification: L13, L14

Keywords: behavior-based price discrimination, network goods, reimbursement, switching costs

* *Chen*: Department of Economics, University of California, Irvine, CA 92697, jiaweic@uci.edu. *Sacks*: School of Business, Clarkson University, Potsdam, NY 13699, msacks@clarkson.edu. We thank Jan Brueckner, Luis Cabral, Yongmin Chen, Linda Cohen, Patrick DeGraba, Amihai Glazer, Lukasz Grzybowski, Pramesh Jobanputra, Byung-Cheol Kim, Lingfang Li, Qihong Liu, Armin Schmutzler, Zhu Wang, Xiaolan Zhou and conference and seminar participants at China Meeting of the Econometric Society, EARIE Annual Conference, International Industrial Organization Conference, MaCCI Annual Conference, ZJU International Conference on Industrial Economics, Claremont McKenna College, Federal Communications Commission, Fudan University, and University of Oklahoma for their helpful comments and suggestions. Anna Ellithorpe provided excellent research assistance. We thank the NET Institute for financial support.

1 Introduction

Many modern industries, both network and non-network, such as financial services, computer hardware and software, dating platforms, healthcare services, and telecommunications are characterized by switching costs – the costs in terms of money, time, or effort that consumers incur when switching between products.¹ Switching lenders requires clearing old debts and closing old accounts to open new accounts (Stango, 2002) and entails losing relationship-based benefits such as easier access to credit and lower interest rates (Barone et al., 2011). Switching health insurance plans often requires consumers to also switch primary care providers (Strombom et al., 2002). Similar stories arise in the information technology industry (Chen and Hitt, 2006), television network industry (Shcherbakov, 2016), and the telephone/wireless industry (Viard, 2007; Cullen and Shcherbakov, 2010; Park, 2011).

This paper develops a dynamic analysis of behavior-based price discrimination (Chen, 1997; Villas-Boas, 1999; Fudenberg and Tirole, 2000; Cabral, 2016) with and without network effects (Cabral, 2011; Chen, 2016).² We investigate a common growth strategy used by firms in network industries: reimbursing the switching costs incurred by consumers switching from rivals and highlight how the reimbursement channel affects both the demand- and supply-side of the market. The model is motivated by recent policies where firms post a common price and a reimbursement that is explicitly tied to a switching cost. The reimbursement may cover only a portion of the switching cost or its entirety, but often does not go beyond the switching cost.

In 2015, Verizon Wireless covered up to \$350 to pay off early termination fees (Goldman, 2015) and currently (as of July 2023) offers up to \$650.³ Spectrum (as of July 2023) offers their competitors’ cable subscribers a “contract buyout” that reimburses up to \$500 in early termination fees (Spectrum, 2021). Reimbursements also apply to non-monetary switching costs. Computer hardware and software companies may provide settings and data migration, file conversion, and training services to new users who switch from rival products (Dell, 2021).

In addition to these pricing policies, our study is also motivated by the many implemented or proposed public policies aimed at reducing switching costs in network industries. For example, mobile phone number portability has been implemented in over 100 countries in the past two decades, with over 40% of numbers ported in many countries (XConnect, 2021). The US Federal

¹The literature on switching costs can be traced back to von Weizsäcker (1984). Shortly thereafter, markets with switching costs were examined in Klemperer (1987a), Klemperer (1987b), and Klemperer (1987c). Since then, much headway has been made. A thorough summary through 2007 is given in Farrell and Klemperer (2007). For more recent surveys see Villas-Boas (2015) and the literature review in Cabral (2016).

²We incorporate network effects in the benchmark analysis.

³The other major wireless carriers AT&T and T-Mobile offer similar reimbursement policies of up to \$800.

Communications Commission considered limiting the early termination fees charged by wireless carriers (German, 2008). The European Competition Authorities proposed providing switching facilities for retail banking and payment systems and implementing bank account number portability (ECAFSS, 2006). In the software industry, common standards that enhance compatibility across different products, such as the Open Document Format (ODF), are being adopted by various governments (Casson and Ryan, 2006). To develop informed policies, policymakers must understand firms' endogenous response to the policies. As a change in switching costs alters firms' choice set with respect to their reimbursement strategy, research into how firms' reimbursement and price choices are affected by a change in switching costs is much needed.

To analyze the reimbursement channel, we build an infinite-horizon duopoly model with network effects and switching costs using the Ericson and Pakes (1995) dynamic computational approach, expanding upon the model in Chen (2016).⁴ An advantage of the infinite-horizon dynamic computational approach is the ability to avoid end-of-game effects and assess both short-run transition dynamics and long-run outcomes. There are two firms and a finite number of consumers. In each period, the two forward-looking firms simultaneously and independently make pricing and reimbursement decisions. In each period, one randomly chosen consumer reevaluates their purchasing decision as in Cabral (2011). The consumer chooses to purchase from one of the two firms or selects an outside option (e.g., no purchase). Consumers are myopic in the main specification, but we show that the results are robust to forward-looking consumers in an extension. We solve for a symmetric Markov perfect equilibrium using numerical methods à la Doraszelski and Satterthwaite (2010) and identify the effects of the reimbursement channel by comparing the equilibrium to the case in which the reimbursement channel is disabled.⁵

The reimbursement strategy is unique relative to traditional models of behavior-based price discrimination (Chen, 1997; Villas-Boas, 1999; Shaffer and Zhang, 2000; Cabral, 2016; Colombo, 2016; De Nijs, 2017; Colombo, 2018).⁶ The reimbursement is only offered to consumers switching from the competitor (and thus face a switching cost) and not to those who previously chose the outside option. Many companies offer introductory prices, e.g., a discount for new customers, but this discount is separate from a reimbursement policy. Amazon, in a highly publicized case, had to publicly apologize and refund customers who had paid higher prices due to the outcry against Amazon's price discrimination that charged regular Amazon customers higher prices (Ramasas-

⁴See Doraszelski and Pakes (2007) for a survey of the literature using this approach.

⁵Dynamic price competition with network effects and switching costs have been studied extensively. Without reimbursement, our framework corresponds to the models in Keller et al. (2010), Suleymanova and Wey (2011), Doganoglu and Grzybowski (2013), and Chen (2016).

⁶See also Fudenberg and Tirole (2000), Gehrig et al. (2011), and Bouckaert et al. (2012).

try, 2005). From a modeling standpoint, these two pricing strategies are identical only if there is no outside option or the market is fully covered. Furthermore, the extent to which firms can price discriminate using the switching cost reimbursement channel changes when the magnitude of switching costs changes due to public policies (such as phone number portability, bank account number portability, and limits on early termination fees) or technological developments (such as enhanced compatibility across products), leading to important policy and managerial implications.

When switching costs cannot be reimbursed, we find that increasing the switching cost relative to the magnitude of the network effect decreases market concentration. This concentration-reducing effect of switching costs is consistent with the existing switching cost literature for both non-network goods (Beggs and Klemperer, 1992; Chen and Rosenthal, 1996; Taylor, 2003) and network goods (Suleymanova and Wey, 2011; Doganoglu and Grzybowski, 2013; Chen, 2016).⁷ The reimbursement channel breaks this pattern of “reversion to the mean” (Cabral, 2011) in contrast to much of the literature on switching costs, e.g., Beggs and Klemperer (1992), Chen and Rosenthal (1996), Taylor (2003), Farrell and Klemperer (2007), and Chen (2016).

The firm with the larger installed base always reimburses a greater share of the switching cost than their competitor, though the share of the switching cost reimbursed need not be monotonic in either firm’s installed base. *A priori*, this pattern is not obvious. With nonconvex network effects, a smaller firm has a (weakly) larger marginal benefit of attracting a new customer than a larger firm. Relatedly, when network effects are present, the larger firm, *ceteris paribus*, is more valuable to a customer than the smaller firm (due to network effects) and thus less enticing (i.e., reimbursement) is necessary to induce switching. On the other hand, the larger firm, by attracting an additional customer, can increase its price to each customer when the network effects are strong. After intense competition to gain the early advantage in market shares, this difference in the two firms’ reimbursement policies gives the winning firm advantage in attracting switching consumers, further increasing its market share, in contrast to Gehrig et al. (2012), Mehra et al. (2012), and Esteves (2014). This pattern persists even absent network effects. Correspondingly, an increase in the switching cost – which increases the magnitude of reimbursement that’s possible – leads to a higher market concentration.

Is the reimbursement channel, much like behavior-based price discrimination more generally, a prisoner’s dilemma as suggested by much of the literature? When network effects are small (or

⁷In the literature on endogenous market dominance, Budd et al. (1993) use a dynamic duopoly model to study whether the larger firm becomes increasingly dominant. They similarly suggest that switching costs make price cuts more costly for the larger firm than for the smaller firm and may overcome the gravitation towards asymmetric market shares and result in a “catch-up” equilibrium.

absent), reimbursements lower producer surplus, which is consistent with much of the behavior-based price discrimination literature (Chen, 1997; Villas-Boas, 1999; Fudenberg and Tirole, 2000; Pazgal and Soberman, 2008; Esteves, 2010; Zhang, 2011; Choe et al., 2018). However, with large network effects, reimbursements break the prisoner’s dilemma and instead increase producer surplus. While this is not the first paper to show that producer surplus can be increased through a form of behavior-based price discrimination, previous papers relied on ex ante asymmetries such as quality differences (Jing, 2017; Rhee and Thomadsen, 2017) or consumer asymmetries such as loyal and price-sensitive consumers (Chen and Zhang, 2009).

While the average price paid by consumers when switching costs are reimbursed may be higher or lower than without the reimbursements, consumer surplus is uniformly higher with reimbursements than without for a given switching cost. The average price is higher when the network effect is significant; however, this increase in price is offset by the increase in consumer value from the larger network built through the reimbursement channel. This result is not obvious. Prices are not set independently of reimbursements. Reimbursements are (potentially partially) financed by higher prices to locked-in consumers. Our results indicate that consumers’ gains from both the increase in network size and the lower effective price paid by switching consumers outweigh the loss in surplus from the higher price paid by repeat customers. Consequently, antitrust analysis that relies on the level of market concentration must be extra careful in network industries with consumer switching costs and reimbursement of such costs. Hence, policies aimed at either reducing switching costs or preventing behavior-based price discrimination, such as the FCC’s aforementioned proposal to limit early termination fees, the ECA’s proposal to reduce switching costs in finance, or the mandating of common standards in hardware and software platforms can backfire and negatively impact consumers.

Our theory of switching cost reimbursement builds upon the dynamic network model with switching costs of Chen (2016). We add to it the endogenous reimbursement channel and forward-looking consumers. Chen (2016) does consider an exogenous reimbursement of 50% of the switching cost by both firms without a viable outside option. We show in this paper that this symmetric response does not persist in equilibrium when market shares are asymmetric.

This paper adds to the interrelated literatures on switching costs, price discrimination, and network effects. The work most closely related to ours is as follows. Dubé et al. (2009), Arie and Grieco (2014), Rhodes (2014), Fabra and García (2015), and Cabral (2016), study switching costs in infinite-horizon dynamic models of price competition. Except for Cabral (2016), those papers have focused on the case in which firms cannot distinguish between locked-in and not locked-in

consumers and hence cannot price discriminate. In recent years, a few papers have emerged that study network effects and switching costs jointly, including Keller et al. (2010), Suleymanova and Wey (2011), Doganoglu and Grzybowski (2013), and Chen (2016, 2018). Those papers show that the interaction between switching costs and network effects plays an important role in determining industry dynamics and market outcomes, but they do not consider switching cost reimbursement.

Chen (1997) and Shaffer and Zhang (2000) are among the first papers to study discriminatory pricing in the context of switching costs. Using a two-period homogeneous-good duopoly model, Chen (1997) finds that firms play a “bargain-then-ripoff” strategy, where the prices in the first period are below marginal cost while prices in the second period are above marginal cost. When engaging in discriminatory pricing, firms are worse off and consumers are not necessarily better off, leading to deadweight losses. The paper finds that discriminatory price is not a function of the firm’s market share, which follows from the model having a finite time horizon. In the present paper, we consider an infinite-horizon model in which firms set both price and switching cost reimbursement. As a result, we find that both the pricing and reimbursement decisions depend explicitly on the firm’s market share.⁸

Shaffer and Zhang (2000) study the properties of price discrimination in a static model with switching costs. They show that when demand is symmetric, a firm charges a lower price to its rival’s consumers (paying to switch). However, when demand is asymmetric, a firm charges a lower price to its own consumers (paying to stay). In the present paper, we incorporate dynamic competition into the analysis and show that in the dynamic equilibrium, each firm reimburses a portion (potentially all) of consumers’ switching costs, in essence charging a lower price to its rival’s consumers and a higher price to its own consumers.

Cabral (2016) studies the effects of switching costs in a dynamic competitive environment in which sellers can discriminate between locked-in and not locked-in consumers. He shows that if markets are very competitive to begin with, then switching costs make them even more competitive; whereas if markets are not very competitive to begin with, then switching costs make them even less competitive. In the present paper, we consider the effects of switching costs on market competitiveness from a different angle, and show that if firms have the option to reimburse consumers’ switching costs, then switching costs make the market less competitive, otherwise they make the market more competitive. In addition, we find that with switching cost reimbursements, when network effects are small, the U-shaped relationship between the average price and the switching cost found in

⁸Prior studies that have emphasized the dynamic nature of network effects include Doganoglu (2003), Mitchell and Skrzypacz (2006), Markovich (2008), Markovich and Moenius (2009), Chen et al. (2009), and Cabral (2011), among others.

Cabral (2016) persists, but with large network effects, we find that the average price is instead monotonically increasing in the switching cost.

Lastly, by studying the effects of public policies that alter switching costs or firms' ability to reimburse switching costs, this paper joins a growing literature that takes the computational dynamic oligopoly equilibrium approach to studying policy implications, such as Gowrisankaran and Town (1997), Benkard (2004), Tan (2006), Ching (2010), Filson (2012), and Chen (2018).

The remainder of the paper is structured as follows. The next section discusses in more detail how this paper relates to prior studies. The model is presented in Section 2. Section 3 discusses the dynamic equilibrium. Section 4 studies the effects of the reimbursement channel. Section 5 examines the robustness of the findings, and Section 6 considers an extension in which consumers are forward-looking. Section 7 concludes.

2 Model

This section develops a dynamic duopoly model of network industries that characterizes the key features of many markets with network effects, switching costs, and their reimbursement. The model uses the Ericson and Pakes (1995) dynamic computational approach. It builds on prior dynamic analyses of network effects and switching costs, particularly Chen (2016), by adding the endogenous reimbursement of switching costs and allowing for forward-looking consumers.⁹

2.1 Supply Side

Time is discrete with an infinite horizon. There are two single-product firms indexed by $j = 1, 2$. The firms' products are referred to as the *inside goods*. There is also an *outside good*, indexed by 0. The goods are durable and subject to stochastic death.

Firm j is described by its state $b_j \in \{0, 1, \dots, M\}$, subject to $b_1 + b_2 \leq M$, where M is the number of consumers. A firm's state indicates the installed base of its product at the beginning of a period, from which the network effect is derived. Each firm moves up or down the "installed base ladder" via product sales and depreciation, detailed in Section 2.2.¹⁰ Denote by $b_0 = M - b_1 - b_2$ the outside good's installed base. The industry state is given by $b = (b_1, b_2)$, and the state space is

$$\Omega = \{(b_1, b_2) \mid 0 \leq b_j \leq M, j = 1, 2; b_1 + b_2 \leq M\}.$$

⁹We discuss forward-looking consumers in Section 5.

¹⁰The installed base ladder in our model is analogous to the quality ladder in the dynamic quality ladder models starting with Pakes and McGuire (1994).

The firms compete to sell to a sequence of buyers with unit demands, with one buyer per period. In each period, given b , the firms simultaneously set their prices and their respective shares of the switching cost to be reimbursed. Denote by p_j the price for good j , by $p = (p_1, p_2)$ the vector of prices, and by $d_j \in [0, 1]$ the share of the switching cost reimbursed by firm j . The outside good’s price p_0 is normalized to zero.

2.2 Demand Side

In each period, one random consumer’s product unit “dies” and she returns to the market to purchase one of the three (inside or outside) goods. Product death may be literal or metaphorical, e.g., an expiring subscription. This modeling approach follows prior dynamic models of network goods, such as Chen et al. (2009) and Cabral (2011). Whereas in those papers, in each period a random old consumer dies and is replaced with a new consumer, here we assume that the random consumer doesn’t die but instead her product unit dies, which allows us to model the consumer’s switching costs.¹¹

Existing dynamic studies of network goods, e.g., Chen et al. (2009), Dubé et al. (2010), and Cabral (2011), often assume that existing consumers face infinite switching costs and therefore stay with their (durable) products until product death or consumer death. Since consumers typically make network choices infrequently, this assumption can be viewed as a reasonable approximation of durable network goods: consumers typically re-optimize when their products die or when they experience certain events (moving to a different location, changing jobs, etc.) that induce them to reconsider their current choice. It is thus reasonable to approximate such events as exogenous shocks and refer to them using the umbrella term “product death”. This assumption is often more reasonable than modeling consumers as making fully informed decisions in every period. For instance, Tom Meyvis, Professor of Marketing at NYU’s Stern School of Business, was quoted by the radio program *Marketplace* as saying: “We’re lazy, we don’t want to think too much. So as long as things are going OK, we tend not to change” (Schwab, 2020).

We therefore maintain the assumption that consumers stay with their products until product death. Specifically, in our model a consumer is *attentive*, i.e., making a purchasing decision (in the presence of switching costs), only when her product unit dies, and remains *inattentive* otherwise.

Denote by $r \in \{0, 1, 2\}$ the good that the attentive consumer previously purchased. With stochastic

¹¹The assumption of stochastic product deaths is also used in prior studies on durable goods such as Swan (1972) and Chen et al. (2013).

product death, the probability that the attentive consumer previously purchased good j is

$$\Pr(r = j|b) = \frac{b_j}{M}, \quad j = 0, 1, 2. \quad (1)$$

The utility a consumer who previously purchased good r receives from purchasing good j is

$$u_{rj} = v_j - p_j - \mathbf{1}(r \neq 0, j \neq 0, r \neq j)(1 - d_j)k + \mathbf{1}(j \neq 0)\theta g(b_j) + \epsilon_j. \quad (2)$$

v_j is the intrinsic product quality, which is fixed over time and common across firms: $v_j = v$, $j = 1, 2$. As the intrinsic quality parameter affects demand only through the quality differential $v - v_0$, we set $v = 0$ without loss of generality and consider different values for v_0 . p_j is the price of good j . A consumer incurs a switching cost $k \geq 0$ if she switches from one inside good to the other, and a portion of her switching cost is reimbursed by the firm if $d_j \in (0, 1]$. In this paper, we focus on exogenous switching costs and abstract from endogenous ones chosen by firms.

The firms do not observe r when they make their price and reimbursement decisions, though they do know its probability distribution. Rather than charging different prices based on whether the consumer is a switching consumer or a repeat consumer, each firm announces a single price and a switching cost reimbursement policy. Hence, price discrimination occurs only through the reimbursement channel.

The increasing function $\theta g(b_j)$ captures the network effect, where $\theta \geq 0$ controls the strength of the network effect. We assume the outside good exhibits no network effects. Note that we model the network effect as based on b_j , the installed base at the beginning of the period before the random product death and the attentive consumer's purchasing decision. The motivation for this specification is that network effects often come from a complementary stock which enhances the value of the network, such as apps for a smartphone ecosystem or video game titles for a video game console. As it takes time for the developers to build up this complementary stock, it is reasonable for the size of the complementary stock to be proportional to the size of the product's customer base with a lag.

When a consumer makes a purchasing decision, she chooses the good that offers the highest current utility. We are then assuming that consumers make myopic decisions. This parsimonious representation of consumers' decision-making allows rich modeling of firms' decisions with respect to price and reimbursement. In some real-world markets such as the printer and ink cartridge market (Miao, 2010), there is evidence that consumers behave myopically, while in some other markets such as the car market (Busse et al., 2013), there is evidence that consumers are forward-looking. We therefore consider in an extension encompassing forward-looking consumers, varying the degree to which consumers are forward-looking to explore how the results are affected in Section 6.

ϵ_j is the consumer's idiosyncratic preference shock, distributed type I extreme value and independent across products, consumers, and time. Therefore, the probability that a consumer who is loyal to good r buys good j is given by the logit choice probability

$$\phi_{rj}(b, d, p) \equiv \frac{\exp(\bar{u}_{rj})}{\sum_{h=0}^2 \exp(\bar{u}_{rh})}, \quad (3)$$

where $\bar{u}_{rj} \equiv u_{rj} - \epsilon_j$ is the deterministic component of u_{rj} . The expected demand for firm j 's product, without observing r , is then $\mathbb{E}_r(\phi_{rj}(b, d, p))$, where the expectation is taken over the probability distribution of r given in (1).

Let $s \in \{0, 1, 2\}$ denote the attentive consumer's product choice. The industry state then transitions based on the joint outcome of the installed base depreciation (product death) and the attentive consumer's purchasing decision:

$$b' = B(b, r, s) = \underbrace{(b_1 - \mathbf{1}(r=1) + \mathbf{1}(s=1))}_{b'_1}, \underbrace{(b_2 - \mathbf{1}(r=2) + \mathbf{1}(s=2))}_{b'_2}. \quad (4)$$

2.3 Bellman Equation

Denote by $V_j(b)$ the expected net present value of current-period and future cash flows to firm j in state b . Firm j 's Bellman equation is given by

$$V_j(b) = \max_{p_j, d_j} \mathbb{E}_r \left[\phi_{rj}(b, d_j, d_{-j}(b), p_j, p_{-j}(b)) (p_j - \mathbf{1}(r \neq 0, r \neq j) d_j k) + \beta \sum_{h=0}^2 \phi_{rh}(b, d_j, d_{-j}(b), p_j, p_{-j}(b)) V_j(b') \right], \quad (5)$$

where $p_{-j}(b)$ is the equilibrium price charged by firm j 's rival and $d_{-j}(b)$ is the equilibrium proportion of the switching cost reimbursed by firm j 's rival. The constant marginal cost of production is normalized to zero, $\beta \in [0, 1)$ is the firms' common discount factor, and the next-period industry state b' at the end of the equation is given by (4).

2.4 Solution Concept

We find a symmetric Markov perfect equilibrium (MPE). I.e., for any $(\tilde{b}, \hat{b}) \in \Omega$, firm 2's MPE strategy in state (\hat{b}, \tilde{b}) is identical to firm 1's MPE strategy in state (\tilde{b}, \hat{b}) . Existence follows from Doraszelski and Satterthwaite (2010). In general, there may exist multiple dynamic equilibria, so we use a selection rule in the dynamic games literature where we compute the limit of the equilibrium of a finite-horizon game as the horizon grows to infinity (Chen et al., 2009).¹²

¹²Computation of the MPE via value function iteration is carried out using MATLAB and the solver KNITRO in the TOMLAB optimization environment.

3 Dynamic Equilibrium

For our analysis, it is useful to define the Markov perfect equilibria according to the limiting (long-run) market structure, as we find two distinct market structures emerge.

Definition 1. A *tipping equilibrium* is a symmetric MPE in which the limiting distribution of the inside firms' installed bases is bimodal.

Definition 2. A *splintered equilibrium* is a symmetric MPE in which the limiting distribution of the inside firms' installed bases is unimodal.

In a tipping equilibrium, the firm that obtains an initial advantage is able to build on that advantage and dominate the market in the long run, resulting in a highly concentrated market. In a splintered equilibrium, the market converges to a symmetric outcome from any initial industry state and, in the long run, the two firms split the market (approximately) evenly. Hence, there is (approximately) minimal market concentration for a duopoly.

3.1 Parametrization

Table 1 summarizes the parameter values used in the analysis. For the baseline specification, we set the quality of the outside good $v_0 = -5$, so the inside goods' intrinsic quality ($v = 0$) is higher than the outside good's, though not high enough to guarantee full market coverage. For the baseline specification, we investigate $11 \times 13 = 143$ (θ, k) combinations. With $M = 20$, the depreciation rate ($1/M$) is 5%. Following Chen et al. (2009), the functional forms for the shape of the network effect are as follows:

$$\text{linear: } g(b_j) = b_j/M$$

$$\text{Convex: } g(b_j) = \sin\left(\frac{b_j}{M} \times \frac{\pi}{2} + \frac{3\pi}{2}\right) + 1 \quad (6)$$

$$\text{Concave: } g(b_j) = \sin\left(\frac{b_j}{M} \times \frac{\pi}{2}\right) \quad (7)$$

$$\text{S-shaped: } g(b_j) = \left(\sin\left(\frac{b_j}{M} \times \pi + \frac{3\pi}{2}\right) + 1\right) / 2. \quad (8)$$

The remaining parameter specifications are presented as robustness checks in Section 5 and Appendix A1 where we provide additional figures plotting the MPE and the resulting market concentration, network benefits, average prices, and consumer, producer, and total surpluses. While our model is not intended to fit any particular industry, some market characteristics emerging from the

Parameter	Values [†]
Number of consumers M	$\{12, 14, \dots, 20^*, \dots, 24\}$
Outside good value v_0	$\{-7, -6, -5^*, -4, -3\}$
Network effect θ	$\{0, 0.5, \dots, 2^*, \dots, 5\}$
Shape of network effect	{Linear*, Convex, Concave, S-shaped}
Switching cost k	$\{0, 0.25, \dots, 1^*, \dots, 2^*, \dots, 3\}$
Consumers' discount factor β_c	$\{0^*, 0.1, \dots, 0.9\}$
Firms' discount factor β	$1/1.05^*$
Long-run (MPE) own-price elasticity range	-1.02 to -0.37
Long-run (MPE) market coverage range	89.4% to 99.8%

[†] Values with a * correspond to those reported in the text. The remaining parameter combinations are reported in the figures and as extensions and robustness checks.

Table 1: Summary of parameter values across all specifications.

baseline parameterizations that we consider are consistent with empirical findings. The own-price elasticities of demand for the firms' products range from -1.02 to -0.37 , which are consistent with those reported in Clements and Ohashi (2005) for video game consoles (-2.15 to -0.18), Dick (2008) for banking services (-0.87 to -0.12), and Gandal et al. (2000) for CD players (-0.54).¹³ Additionally, the combined market share of the inside goods ranges from 89.4% to 99.8%. These percentages are consistent with the percentage of U.S. households with a bank account at 93% in 2013 (Furman, 2016).

3.2 The Reimbursement Channel

We highlight four properties of the firms' switching cost reimbursement strategy in the MPE. First, the share of the switching cost reimbursed is a non-monotonic function of a firm's installed base. Second, the firm with the larger installed base reimburses a greater share of the switching cost than their smaller competitor. Third, the entire switching is often reimbursed by the larger firm in the limiting state.¹⁴ Fourth, the level of the switching cost has little effect on the share reimbursed. Figures 1(a) and 1(b) plot the equilibrium reimbursement policy for all states $b = (b_1, b_2)$. To more clearly visualize the reimbursement policy, Figure 1(c) plots the equilibrium reimbursement policy when $b_2 = 20 - b_1$ (full market coverage).

Suppose that firms initially start with approximately equal installed bases, so competition is intense to gain the early advantage. Then, each firm reimburses between 10% and 33% of a switching cost of 1 and between 5% and 29% of a switching cost of 2. The share of the switching cost reimbursed during this intense stage of competition is strictly increasing in the market size (and hence the

¹³This elasticity is computed from the results reported in Gandal et al. (2000).

¹⁴This property holds in many, but not all parameterizations, as illustrated in Figure 10(a) in Section 5.

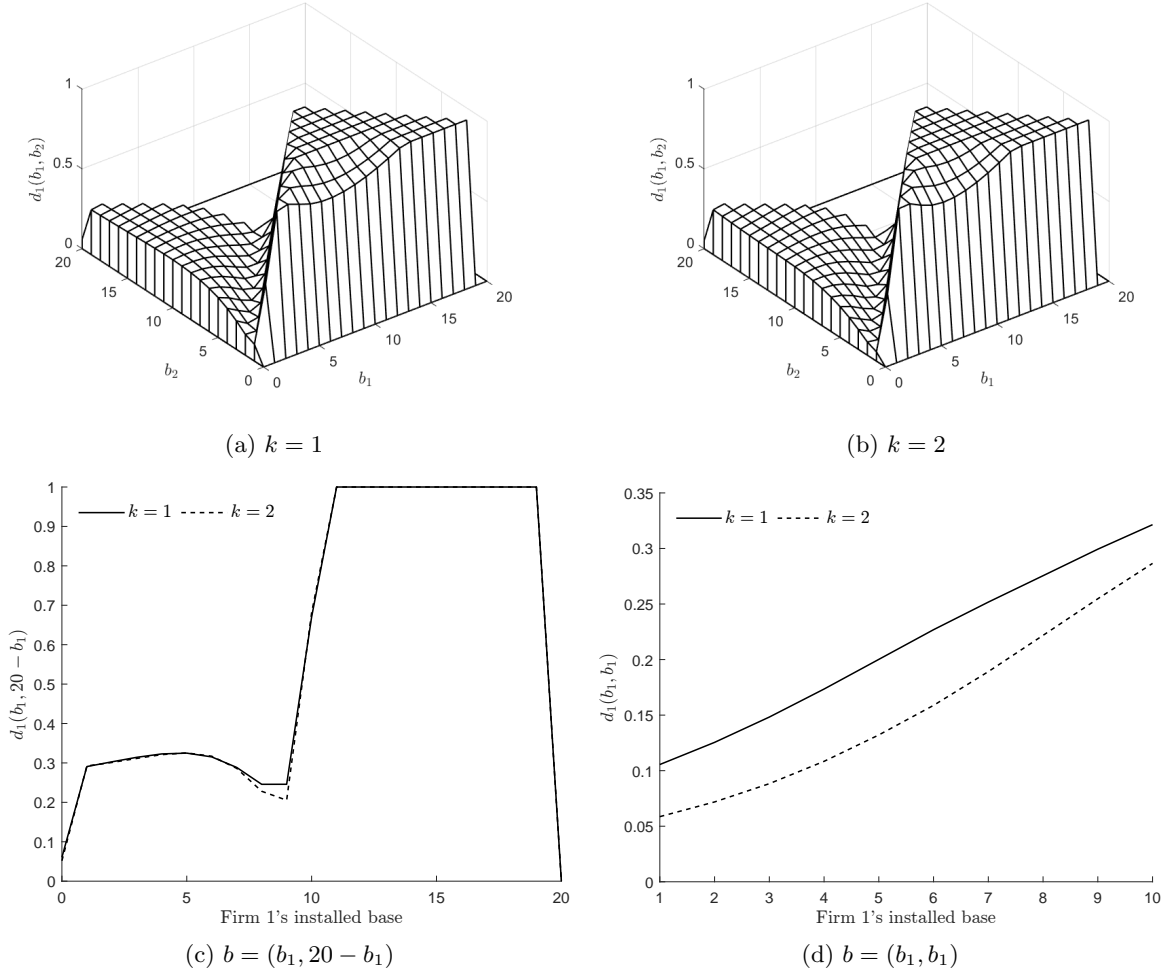

Figure 1: Reimbursement policies given $k = 1, 2$ and $\theta = 2$.

relative value of the inside and outside good $v - v_0$), as illustrated in Figure 1(d). The firm that obtains the early advantage significantly and rapidly increases the reimbursed share, though this increase may slightly taper off if the winning firm attracts enough consumers. The losing firm initially increases its share reimbursed as well, but this reimbursement tapers off as it loses consumers. Hence, the reimbursement policy is nonmonotonic and highly dependent on both market shares and the degree of market coverage.

As discussed in the Introduction, it is *a priori* not obvious that the larger firm reimburses a larger share than their smaller competitor. Nonconvex network effects imply that, all else equal, the smaller firm has a greater marginal benefit of attracting a new customer, as that will (weakly) increase the value of their good by (weakly) more than it would for the larger firm. Hence, by attracting the new customer, the smaller firm can increase its price (and thus profits) by more than

the larger firm. On the other hand, the firm with the larger installed base can charge a higher price to locked-in customers due to the network effect and thus by adding an additional customer can further increase its price. Our analysis suggests that the second effect dominates the first. We show in Section 5 that the second effect continues to dominate even with concave network benefits.

Inspecting Figures 1(a)-(c), the larger firm reimburses a greater share of the switching cost than the smaller firm.¹⁵ This pattern is particularly obvious by taking $v_0 \rightarrow -\infty$, so the market is covered ($b_1 + b_2 = 20$). In this case, when $b_1 = b_2 = 10$, each firm reimburses 67% of the switching cost when $k = 1$ and 68% of the switching cost when $k = 2$. If firm 1 obtains the advantage and the subsequent state is $b_1 = 11$ and $b_2 = 9$, then firm 1 reimburses the entire switching cost for both $k = 1$ and $k = 2$ while firm 2 reimburses only 25% of the switching cost when $k = 1$ and 21% of the switching cost when $k = 2$. Figure 1(c) shows the persistence of this pattern for all asymmetric states.

We discuss the third result – that the larger firm often reimburses the entirety of the switching cost in the limiting state – in greater detail below when we discuss the market structure. Computing the difference in the switching costs across all states when $k = 1$ and $k = 2$, we find that the difference in reimbursements between $k = 1$ and $k = 2$ is bounded above (in absolute terms) by 0.0681 percentage points.

3.3 Prices and Market Shares

When switching costs can be reimbursed, the firms pricing strategies balance the well-known harvesting and investing tradeoff (Farrell and Klemperer, 2007) by employing what resembles a bargain-then-ripoff strategy (Chen, 1997), which we plot in Figures 2(a) and 2(b). During the intense early stages of competition (when installed bases are approximately equal), the firms price below marginal cost — the bargain — to invest in new customers. Combining the low price with the approximately 67% switching cost reimbursement, one of the firms obtains the early advantage. At that point in time, the smaller firm increases its price while lowering the share of the switching cost reimbursed — the ripoff — to harvest its existing demand. The larger firm also raises its price, harvesting its locked in consumers while *raising* its reimbursed share to simultaneously invest in new customers by inducing switching. Hence, the market ends in a tipping equilibrium with the firm obtaining the early advantage maintaining and growing that advantage. We plot the market dynamics in Figures 2(c) and 2(d). Increasing the switching cost amplifies the bargain and subsequent ripoff, but does not affect the underlying market structure.

¹⁵This pattern holds in every parametrization considered (see Figure 10(a)).

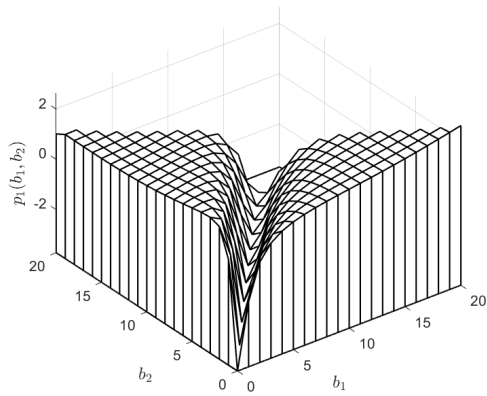

(a) pricing policy, $k = 1$

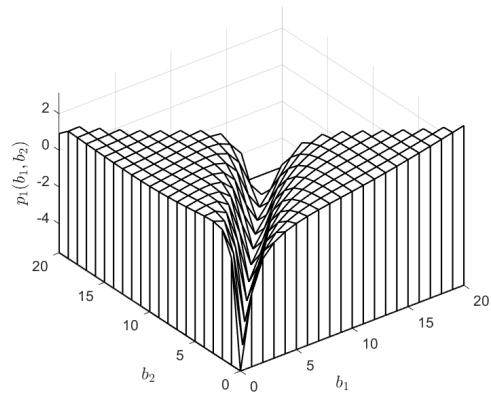

(b) pricing policy, $k = 2$

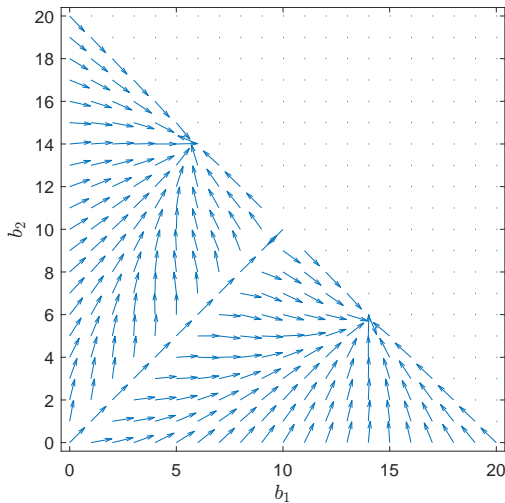

(c) resultant forces, $k = 1$

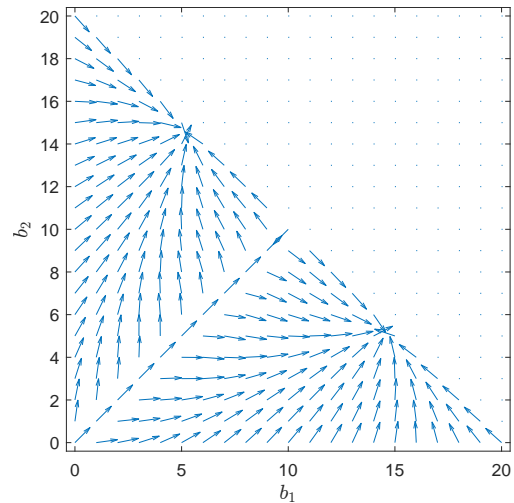

(d) resultant forces, $k = 2$

Figure 2: Equilibrium pricing policies and resultant forces given $\theta = 2$.

3.4 Welfare

We now analyze how changes in the network effect and switching cost affect consumer surplus and producer surplus when the firms reimburse the switching costs.

Definition 3. The *consumer surplus* is the net per-period individual utility aggregated over all consumers, both attentive and inattentive, averaged across all industry states using the probabilities in the limiting distribution as weights.

Definition 4. The *producer surplus* is expected firm profits in one period aggregated over both firms, averaged across all industry states using the probabilities in the limiting distribution as weights.

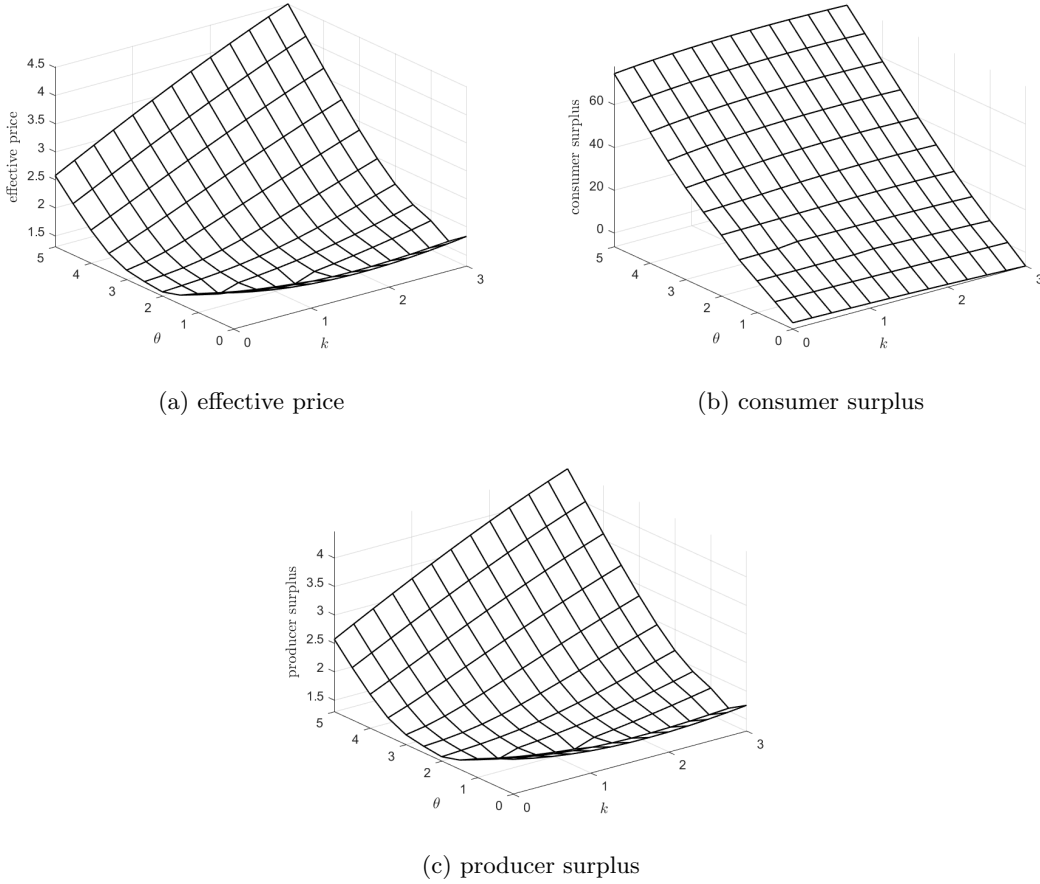

Figure 3: The effective price, consumer surplus, and producer surplus for $(\theta, k) \in \{0, \dots, 5\} \times \{0, \dots, 3\}$.

To better understand both surpluses, we also examine the average price.

Definition 5. The *average price* is the average effective price charged to the attentive consumer by the firms, weighted by the probabilities of the attentive consumer's attachment (1), the two firms' expected sales, and the probabilities of the industry state in the limiting distribution. For switching consumers, the effective price is equal to the nominal price minus the switching cost reimbursement which the consumer receives from the firm.

For any given switching cost, we find that the average price takes on the well-known U-shape as the network effect increases. For a fixed but small network effect, we also see a similar U-shaped pattern, where the average price is U-shaped in the switching cost, as in Cabral (2016). However, as the network effect grows, we find that this pattern is eliminated and the average price is monotonically increasing in the switching cost. These patterns are visualized in Figure 3(a).

Changes in switching costs have little effect on consumer surplus. This is not surprising, as in the limiting distribution, essentially all of the switching costs are reimbursed by the seller. Hence, the only (small) changes in consumer surplus are not driven by the switching cost itself, but by how the increased switching cost slightly increases prices to locked in consumers. This result highlights the important role that switching cost reimbursement plays in determining the effects of switching costs on consumer welfare. A public policy that reduces consumers' switching costs, such as phone number portability and bank account number portability, would increase consumer welfare if firms do not have the option to reimburse switching costs, but would have little effect on consumer welfare if firms have that option. The consumer surplus is plotted in Figure 3(b).

Producer surplus follows the effective price quite closely. Recall that the inside goods' quality is $v = 0$ while the outside good's quality is $v_0 = -5$, so that most of the market is covered by the firms, as is the case in industries such as mobile phone services and banking services. As a result, the firms' combined profits, which equal the sum of the firms' expected sales times the average price (recall that the marginal cost has been normalized to 0), are close to the average price because the sum of the firms' expected sales is close to 1 due to the inferiority of the outside good. The consumer surplus is plotted in Figure 3(c).

4 The Effects of Switching Cost Reimbursement

We now analyze how switching cost reimbursements affect prices, market structure, and surpluses. We do so by comparing, for each (θ, k) combination, the prices, market structure, and surpluses when the reimbursement channel is active to those values when it is inactive (no reimbursement). When switching costs are small, the effects are minimal as the switching cost, and thus the reimbursement, do not significantly alter the consumer's optimization problem. However, with larger switching costs, the reimbursement channel significantly impacts pricing strategies, the market structure, and the corresponding consumer and producer surpluses.

4.1 Low Switching Costs ($k = 1$)

When the switching cost is small, there is little effect of the reimbursement on the MPE structure and pricing policies. With or without the reimbursement channel, the MPE is a tipping equilibrium where the firms practice the well-established bargain-then-ripoff strategy (Chen, 1997; Farrell and Klemperer, 2007), illustrated in Figures 4(a) and 4(b).

The firm that obtains the early advantage maintains it, leading to the tipping equilibrium. The resultant forces are depicted in Figure 5(a). The dominant firm builds on their advantage with the

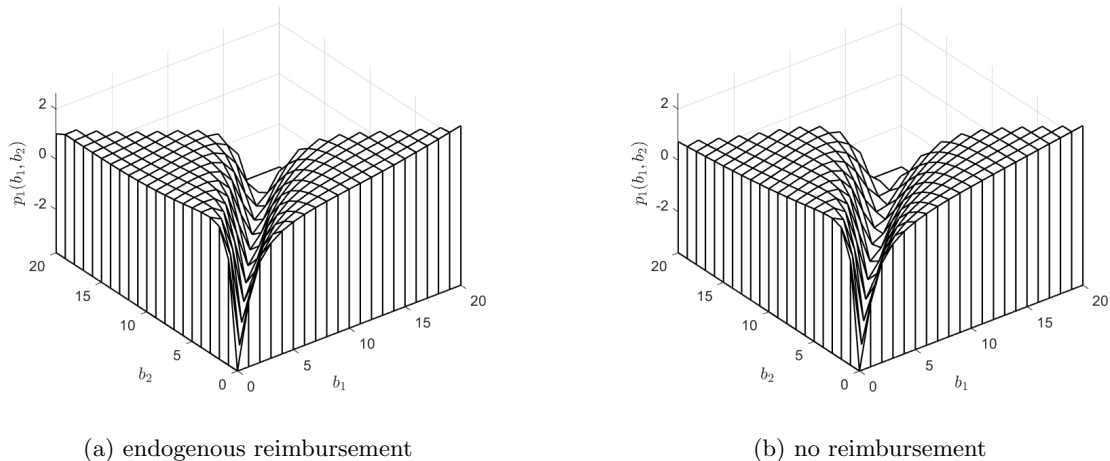

Figure 4: Equilibrium pricing policy given $k = 1$ and $\theta = 2$.

increasing network benefits stemming from an increasing installed base allowing them to charge higher prices than their smaller competitor. However, this process does not rely on the reimbursement channel and occurs regardless. The limiting distribution, plotted in Figure 5(b), illustrates the bimodal tipping equilibrium, which again persists with or without the switching cost.¹⁶ Overlaying the limiting distribution with the reimbursement policy illustrates our fourth property of the reimbursement channel: for all $b = (b_1, b_2)$ with significant mass in the limiting distribution, the larger firm reimburses the entirety of the switching cost. While this complete reimbursement pattern does not hold for all 4,200 parameter specifications (including the robustness checks) the larger firm always reimburses over 50% of the switching cost while the smaller firm always reimburses under 50%.

Given that the switching cost is low (at $k = 1$), it is unsurprising that the reimbursement channel has little effect on the market structure. In this case, the dynamics are driven by the network effect. Recall that, in the baseline specification, the network effect is $\theta = 2$ and $g(b_j) = b_j/20$. Hence, when competition is intense and firms are battling to obtain a majority, $\theta g(b_j) \approx 2 \times (1/2) = k$. Once a firm obtains an advantage, the network effect dominates the switching cost, so reimbursements have relatively little effect on the consumers' decisions.

4.1.1 High Switching Costs ($k = 2$)

With a large switching cost, the reimbursement channel has significant effects on both pricing and the market structure, and therefore the resulting welfare effects. Without the reimbursement chan-

¹⁶Figure A1 in Appendix A1 plots these figures when there is no reimbursement.

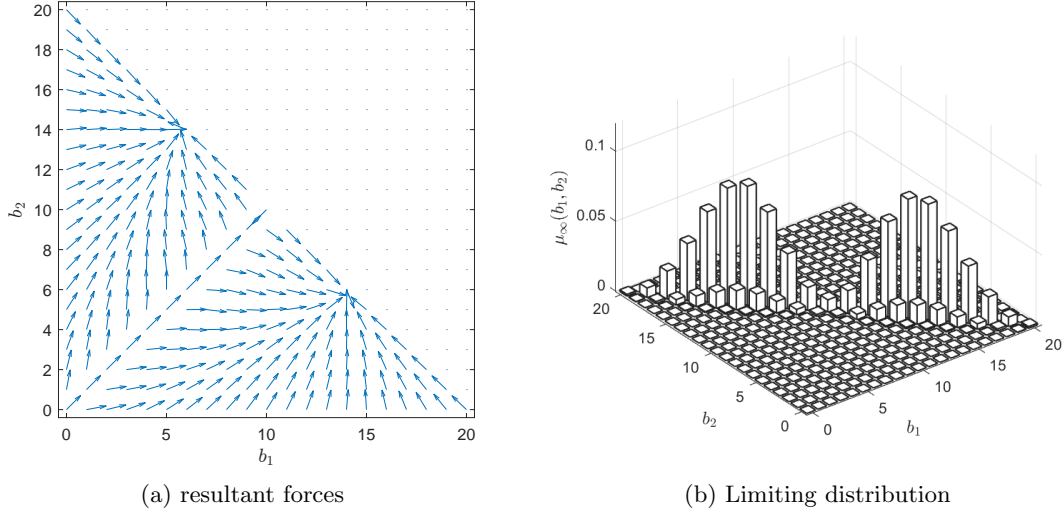

Figure 5: Resultant forces and limiting distribution of installed bases with reimbursements and a switching cost of $k = 1$.

nel, the firms do not engage in a bargain-then-ripoff strategy. While the larger firm still sets a higher price than their smaller competitor, prices are at their peak when installed bases are approximately symmetric for any degree of market coverage. This symmetry price is correspondingly increasing in the degree of market coverage (or as $v - v_0$ increases), as illustrated in Figure 6(d). Prices then trend downward as the degree of asymmetry in installed bases increases, though for a large enough installed base, the network effect allows the price to rise slightly. This pricing policy without reimbursement is illustrated in Figure 6(b), and the case of full market coverage is more clearly illustrated in Figure 6(c).

With a large switching cost and no reimbursement, the degree to which consumers are locked in is significant. As a result, only mismatched consumers (those with strong unobserved preferences for an inside good that is different than their current good) switch. In this instance, a splintered equilibrium with high prices persists in the long run. Hence, we see a pattern of reversion to the mean as in Cabral (2011). Turning on the reimbursement channel eliminates this lock-in problem and allows firms to continue to implement the bargain-then-ripoff strategy.

The effect of the bargain-then-ripoff pricing strategy, when coupled with the reimbursement channel, is identical to the low switching cost case. Rather than a splintered equilibrium, a tipping equilibrium emerges. The firm that obtains the early advantage maintains that advantage and achieves market dominance in the long run.

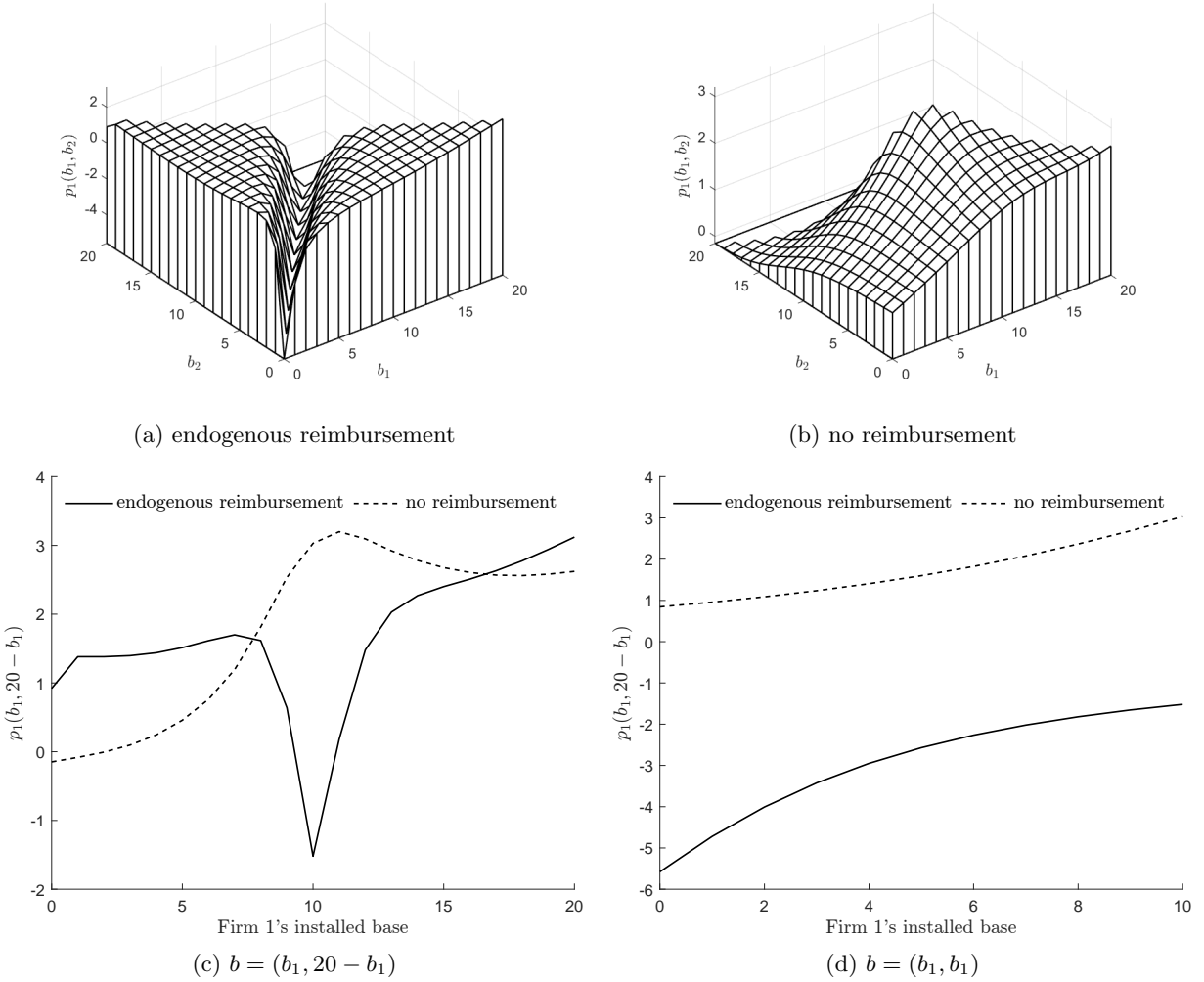

Figure 6: Equilibrium pricing policy given $k = 2$ and $\theta = 2$.

4.1.2 Welfare

We now examine how the reimbursement channel affects the consumer surplus and the producer surplus.

Consumers never find themselves worse off when the firms are given the option to reimburse the switching costs, regardless of their magnitude or the magnitude of the network effect. Not only are the consumers always better off, but the increases in consumer surplus generated through the reimbursement channel can be substantial. With strong network effects and high switching costs, e.g., $\theta = 5$ and $k = 3$, the reimbursement channel increases surpluses by approximately 47%, from 52.5 to 76.9. In the baseline case with low switching costs, $\theta = 2$ and $k = 1$, the reimbursement channel increases switching costs by approximately 5.1%, from 21.5 to 22.6. When the switching

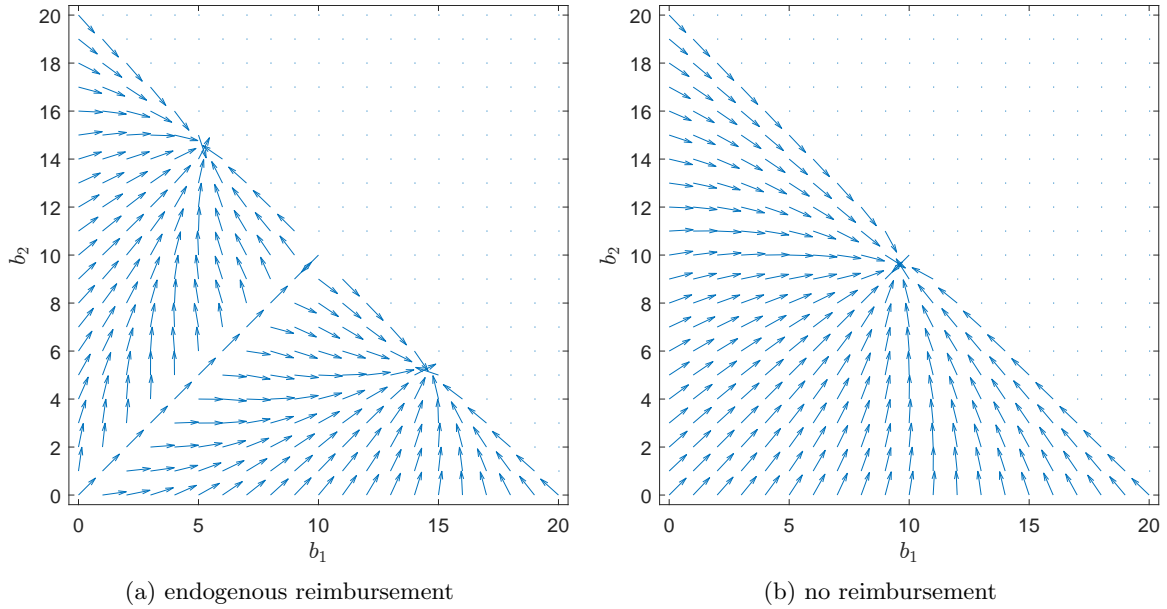

Figure 7: Resultant forces given $k = 2$ and $\theta = 2$.

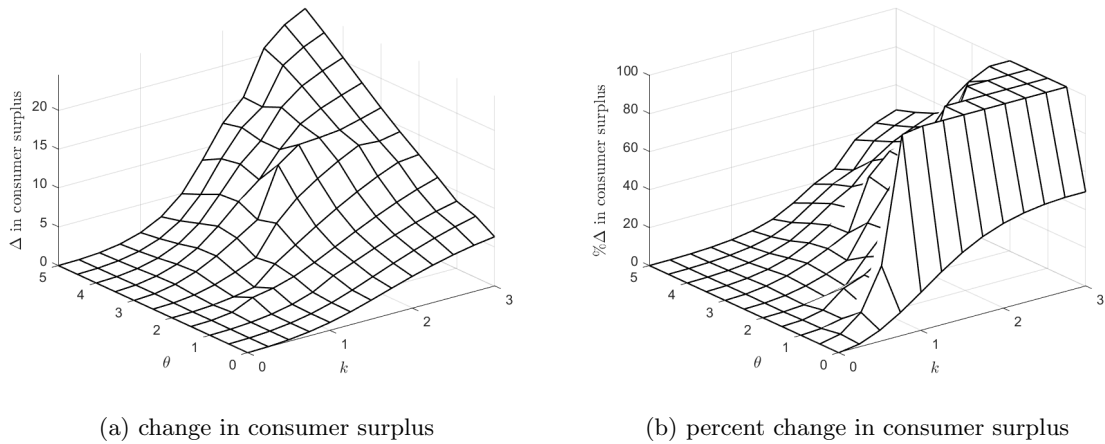
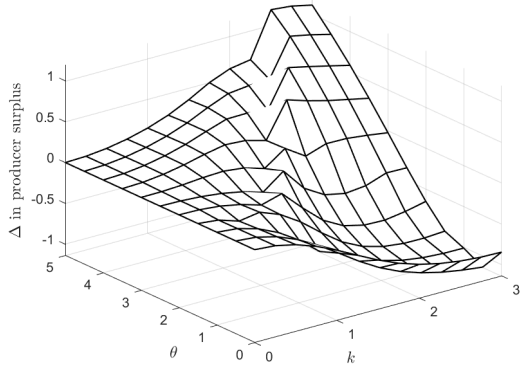

Figure 8: Changes in consumer surplus for $\theta \in \{0, 0.5, \dots, 5\}$ and $k \in \{0, 0.25, \dots, 3\}$. For expositional clarity, the percentage change figure has been capped at 100%, though for small θ and large k , the percentage changes significantly exceed 100%.

costs are increased to 2, the reimbursement channel increases consumer surplus by approximately 57.5%, from 14.5 to 22.9. The sharp difference follows from the change in equilibrium structure for $k = 2$. When $k = 1$, there is a tipping equilibrium with and without reimbursement. However, for $k = 2$, the market structure changes from a splintered equilibrium to a tipping equilibrium when turning on the reimbursement channel.

Three general patterns emerge with respect to the effect of the reimbursement on consumer surplus.



(a) change in producer surplus

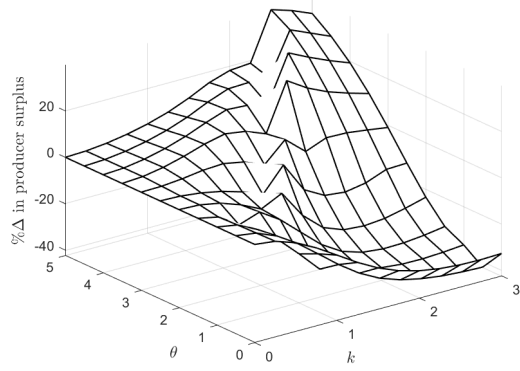

(b) percent change in producer surplus

Figure 9: Changes in producer surplus for $\theta \in \{0, 0.5, \dots, 5\}$ and $k \in \{0, 0.25, \dots, 3\}$.

First, for any given network effect θ , the increase in consumer surplus generated by the reimbursement channel is monotonically increasing in the magnitude of the switching cost k , as illustrated in Figure 8(a). Second, and also illustrated in Figure 8(a), for low-to-intermediate switching costs k , the increase in consumer surplus generated by the reimbursement channel is non-monotonic in the size of the network effect, while it is monotonically increasing in the network effect for large k . The increases are largest when the switching cost is large, as this is the case when the reimbursement transforms the equilibrium from a splintered equilibrium to a tipping equilibrium. As a result, the market is significantly more concentrated, which generates a larger network benefit from consumers of the good with the larger installed base. Third, the percentage change in consumer surplus generated from the reimbursement channel is greatest when the network effects are small. This pattern is illustrated in Figure 8(b).

We now turn our attention to producer surplus and assess whether the reimbursement channel is strategically advantageous or induces a prisoner's dilemma. We find that the answer depends explicitly on the network effect. When the network effect is small, the reimbursement channel lowers producer surplus, indicating that the reimbursement channel induces an asymmetric prisoner's dilemma. This decrease can be substantial, bottoming out at a decrease of approximately -42%, from 2.7 to 1.6. To the contrary, the reimbursement channel increases producer surplus when the network effect is large. Like the decrease in the small network effect case, this increase can be substantial, topping out at approximately 39.6%, from 3 to 4.2. Figure 9(b) plots the percentage change in produce surplus for all baseline parameter combinations. There is significant interaction between the switching cost, network effect, and reimbursement channel. The magnitude of the network effect plays an explicit role in whether firms expect to benefit from the option to reimburse

or only use it as a shield to prevent their competitor from using reimbursements against them. While it is clear that consumers would be in support of any policy that makes reimbursements easier, it is less clear whether industry participants would support such a measure.

As the producer surplus and average price follow each other closely, the increased consumer surplus from the reimbursement channel comes primarily from a higher network benefit and the increased consumer surplus comes primarily from a lower average price when network effects are weak. Our results thus suggest that firms' reimbursement of consumers' switching cost is total welfare-enhancing, and such welfare gains are particularly large in industries with strong network effects and switching costs, providing support for public policies that allow or even promote this form of behavior-based price discrimination. These results have useful policy implications, as they show that with endogenous reimbursement of switching costs, even though the market is more concentrated, the network benefit is greater and the average price is often lower than a less concentrated market without switching cost reimbursement, thus benefiting consumers. Therefore, an antitrust authority relying on the market concentration for its antitrust analysis must exercise caution in industries with switching costs. If the firms are practicing price discrimination via the reimbursement channel, then consumer surplus is actually greater in these markets than it would be if such price discrimination were to be restricted by the authority.

5 Robustness of Findings

The above findings were obtained by varying network effect $\theta \in \{1, 2, 3, 4, 5\}$ and switching cost $k \in \{1, 2, 3\}$ while using the baseline parameter values of $v_0 = -5$, $M = 20$, and the linear network effect function. In this section, we examine the robustness of those findings by considering a wide range of parameterizations.

By varying $v_0 \in \{-7, -6, -5, -4, -3\}$, we allow the quality differential between the inside goods and the outside good to vary considerably, which results in a wide range of market size (the degree of market coverage), ranging from 76.63% to 99.99%. In our model, one out of M consumers in each period experiences product death and becomes attentive, while the other $M - 1$ consumers are inattentive and keep their existing products, exhibiting consumer inertia (see Dubé et al. (2010), Handel (2013), and Hortaçsu et al. (2017) for examples of consumer inertia in consumer packaged goods markets, health insurance markets, and residential electricity markets, respectively). In the robustness checks, we vary the rate of product death (products die at the rate of $1/M$ in each period) and the degree of consumer inertia (a fraction $1/M$ of the consumers are attentive in each period) by varying the value of $M \in \{12, 14, \dots, 24\}$, and assess the robustness of the results. In

the main analysis, we assumed $g(b_j) = b_j/M$. In the robustness checks we consider an additional three functions given by (7)-(8) — {concave, convex, s-shaped} — to assess the robustness of the results.¹⁷ We also consider the cases in which the reimbursement channel is turned on (ER) and when there is no reimbursement (NR).

Hence, we run a total of $5 \times 3 \times 5 \times 7 \times 4 \times 2 = 4,200$ parameterizations. We compute the equilibrium for each parametrization in this set and examine whether the results discussed above hold. Figures 10 and 11 provide succinct summaries of the robustness checks.

Reimbursement. Figure 10(a) compares the larger firm’s reimbursement with the smaller firm’s reimbursement. In this panel, each point corresponds to a $(\theta, k, v_0, M, shape)$ combination, where *shape* denotes the shape of the network effect function (so there are $5 \times 3 \times 5 \times 7 \times 4 = 2100$ points in this plot). For each point, the vertical coordinate is the larger firm’s reimbursement while the horizontal coordinate is the smaller firm’s reimbursement. The larger firm’s reimbursement is defined as a firm’s average reimbursement across all the states in which its installed base is larger than its rival’s (using the states’ probabilities in the limiting distribution as the weights when computing the average). The smaller firm’s reimbursement is defined analogously. For comparison purposes, the 45-degree line is also drawn.

Notice that all the points in Panel (a) are located above the 45-degree line, indicating that for each parametrization that we consider, the larger firm reimburses a larger proportion of the switching costs than the smaller firm. Specifically, across all the parameterizations considered, the larger firm’s reimbursement ranges from 0.61 to 1.00, while the smaller firm’s ranges from 0.07 to 0.58, and the difference between the two ranges from 0.13 to 0.93.

Furthermore, inspection of the data shows that for many parameterizations, the larger firm chooses to fully reimburse the switching cost, indicating that for the larger firm, the upper bound of reimbursement at 100% is often binding. This pattern illustrates a point we made earlier in the introduction. In markets where overt behavior-based price discrimination may face significant backlash, switching cost reimbursement may be the firms’ only (or most substantial) channel of price discrimination based on past purchases, and the extent to which firms can price discriminate using this channel changes when the magnitude of switching costs changes due to public policies or technological developments. Therefore, in order to make well-informed decisions, policymakers and firm managers alike need to take into consideration this impact of switching costs changes on

¹⁷For example, Swann (2002) explores functional forms of network effects in a model of a telephone network and suggests that in theoretical models with network effects, the character of the results depends on the functional form of network effects.

firm behavior.

Market Concentration. Panels (b)-(d) relate to Market Concentration. Panel (b) compares the market concentration with and without reimbursement. In this panel, each point corresponds to a $(\theta, k, v_0, M, shape)$ combination. For each point, the vertical coordinate is the market concentration (as defined previously) under reimbursement while the horizontal coordinate is the market concentration without reimbursement. Notice that although the points in Panel (b) span a wide range of locations, they are all located above the 45-degree line, indicating that for the same parametrization, the reimbursement channel increases the market concentration.

Panel (c) compares the market concentration at high switching costs with the market concentration at low switching costs without reimbursement. In this panel, each point corresponds to a $(\theta, v_0, M, shape)$ combination (so there are $5 \times 5 \times 7 \times 4 = 700$ points in this plot). For each point, the vertical coordinate is the market concentration when $k = 3$ without reimbursement, while the horizontal coordinate is the market concentration when $k = 1$ without reimbursement. The points in Panel (c) are located below the 45-degree line, indicating that without reimbursement, an increase of switching cost k from 1 to 3 lowers the market concentration.

Panel (d) is similar to Panel (c) but plots the case in which the reimbursement channel is enabled. In contrast to Panel (c), the points in Panel (d) are located above the 45-degree line, indicating that when switching costs can be reimbursed, an increase of switching cost k from 1 to 3 increases the market concentration.

Welfare. Panels (e)-(i) relate to welfare. Panel (e) compares consumer surplus (CS) under ER with CS under NR. In this panel, each point corresponds to a $(\theta, k, v_0, M, shape)$ combination. For each point, the vertical coordinate is the CS under ER, while the horizontal coordinate is the CS under NR. The points in Panel (e) are located above the 45-degree line, indicating that for the same parametrization, ER results in a higher CS than NR does. Panel (f) plots total surplus (TS) rather than CS. The points in Panel (f) are also located above the 45-degree line, indicating that for the same parametrization, ER results in a higher TS than NR does. Panel (g) plots producer surplus (PS). In this panel, some points are located above the 45-degree line, while some points are located below it, indicating that in general, firms' option to reimburse consumers' switching costs under ER has an ambiguous effect on producer surplus.

Panels (h) and (i) also plot PS, but focus on the subsets of parameterizations with weak network effects and strong network effects, respectively. Specifically, while the overall plot in Panel (g) has $\theta \in \{1, 2, 3, 4, 5\}$ (2100 points in total), Panel (h) plots for weak network effects with $\theta = 1$ (420

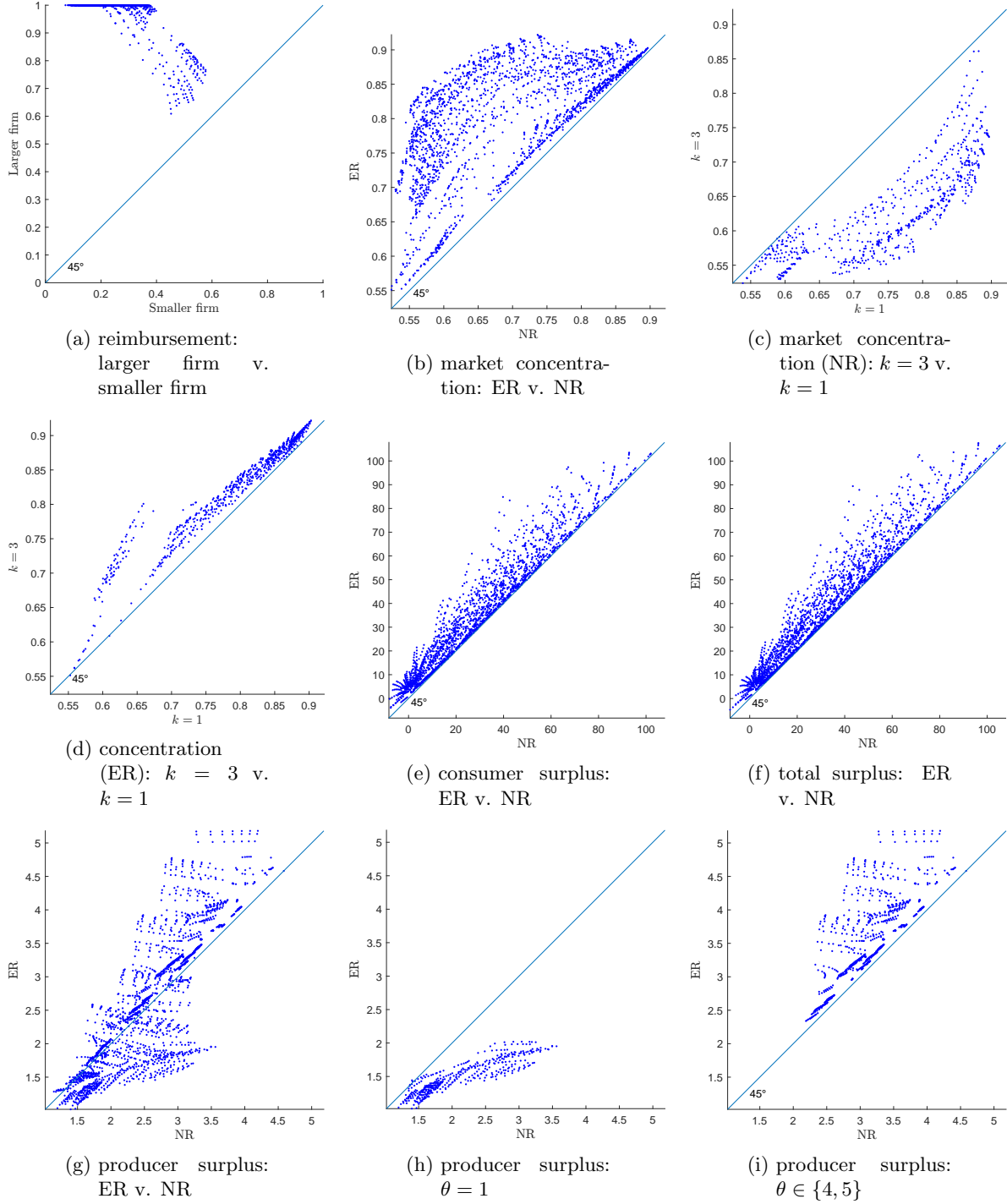

Figure 10: Scatter plots of robustness check results. Each point corresponds to a parametrization. $\theta \in \{1, 2, 3, 4, 5\}$, $k \in \{1, 2, 3\}$, $v_0 \in \{-7, -6, -5, -4, -3\}$, $M \in \{12, 14, \dots, 24\}$, shape of network effect function $\in \{\text{linear, convex, concave, s-shaped}\}$.

points) and Panel (i) plots for strong network effects with $\theta \in \{4, 5\}$ (840 points). The points in Panel (h) are located below the 45-degree line, and in contrast, the points in Panel (i) are located

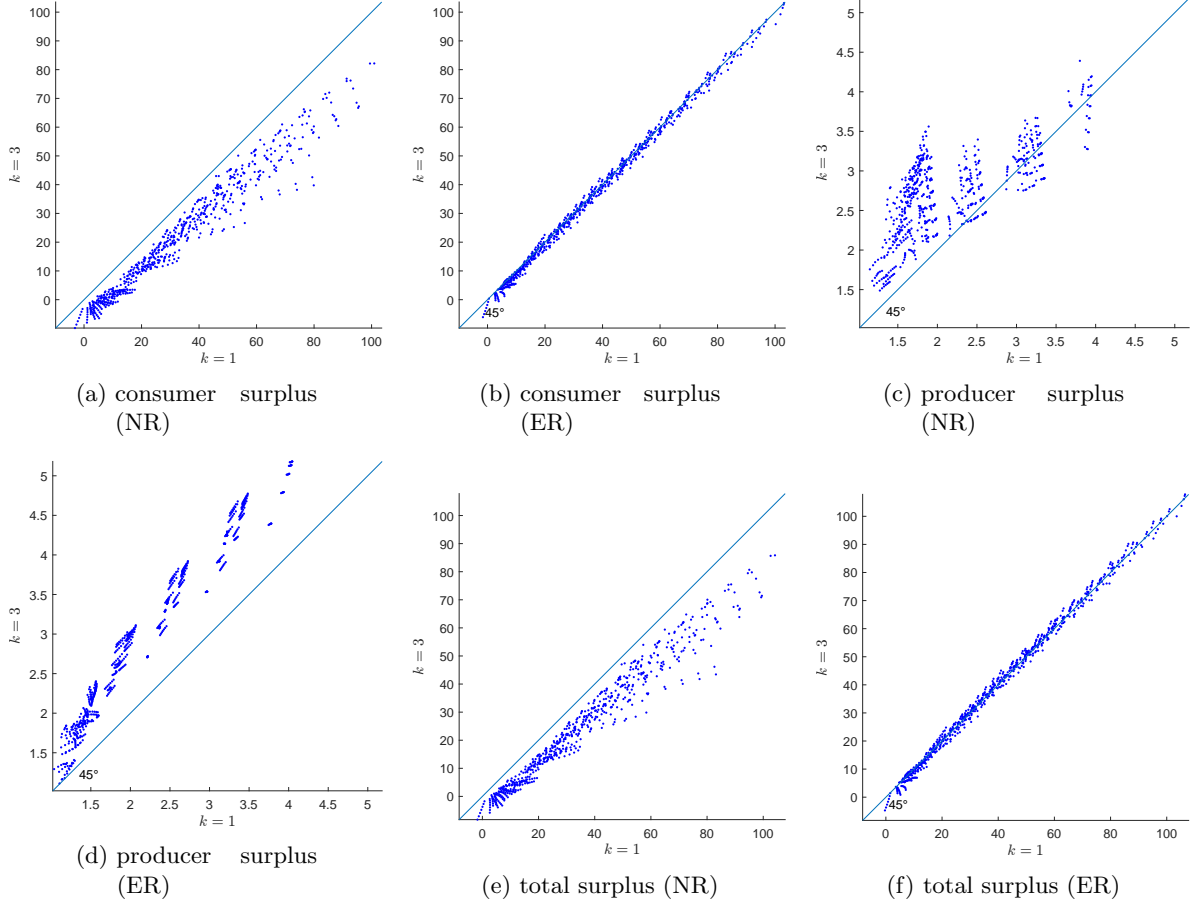

Figure 11: Scatter plots of robustness check results for $k = 3$ v. $k = 1$. Each point corresponds to a parametrization. $\theta \in \{1, 2, 3, 4, 5\}$, $v_0 \in \{-7, -6, -5, -4, -3\}$, $M \in \{12, 14, \dots, 24\}$, shape of network effect function $\in \{\text{linear, convex, concave, s-shaped}\}$.

above it, indicating that compared to NR, ER results in lower producer surplus when network effects are weak and higher producer surplus when network effects are strong.

Figure 11 reports additional welfare results from the robustness checks. Panel (a) compares consumer surplus at high switching costs with consumer surplus at low switching costs without reimbursements. In this panel, each point corresponds to a $(\theta, v_0, M, \text{shape})$ combination. For each point, the vertical coordinate is consumer surplus when $k = 3$ while the horizontal coordinate is consumer surplus when $k = 1$. The points in Panel (a) are located below the 45-degree line, indicating that when the reimbursement channel is disabled, an increase of switching cost k from 1 to 3 lowers consumer surplus. Panel (b) is similar to Panel (a) but activates the reimbursement channel. In contrast to Panel (a), the points in Panel (b) are located on or near the 45-degree line, indicating that an increase in the switching cost k from 1 to 3 leaves consumer surplus largely unchanged.

Panels (c)-(f) are similar to Panels (a)-(b) but plot producer surplus and total surplus instead. Panels (c)-(d) show that an increase of switching cost k from 1 to 3 has an ambiguous effect on producer surplus when the reimbursement channel is disabled and tends to increase producer surplus when the reimbursement channel is enabled. Panels (e) and (f) show that an increase of switching cost k from 1 to 3 lowers total surplus when the reimbursement channel is disabled, but leaves total surplus largely unchanged when the reimbursement channel is enabled.

In summary, while the large set of parameterizations we consider here result in a wide range of market outcomes in terms of firms' reimbursement choices, market size, market concentration, and welfare measures, those market outcomes continue to be consistent with the results described in Section 4.

6 Extension: Forward-Looking Consumers

In this section, we consider an extension in which consumers—in addition to firms—are forward-looking by introducing an additional parameter, the consumers' discount factor $\beta_c \in [0, 1)$, into the model. We examine the results as we vary β_c . The model with myopic consumers corresponds to $\beta_c = 0$. When $\beta_c > 0$, consumers are forward-looking and value not only their current-period utility but also their discounted future utilities. The other assumptions of the model remain unchanged, including the assumption that consumers are attentive only when their existing products die. The firms continue to be forward-looking with discount factor β . The details of this modified version of the model are presented in Appendix A2, which describes both consumers' and firms' Bellman equations as well as the equilibrium conditions for Markov perfect equilibrium of this infinite-horizon dynamic game with forward-looking agents on both sides of the market.

The results from this extension show that our earlier findings are robust and furthermore shed light on the effects of consumers' forward-looking behavior, as illustrated by Figure 12. The figure plots for $v_0 = -5$, $M = 20$, $\theta = 0.4$, $k \in \{0, 0.2, \dots, 2\}$, and $\beta_c \in \{0, 0.1, 0.3, 0.5, 0.7, 0.9\}$. $\beta_c = 0$, the myopic case, is included for comparison purposes. In the figure, the left column of panels plot the market size (the two firms' combined installed base as a proportion of M), and the right column of panels plot the market concentration (the larger firm's installed base as a proportion of the two firms' combined installed base). We discuss three findings.

First, when consumers are myopic, increases in the switching cost k don't cause market size to shrink much (see $\beta_c = 0$ in Panels (a) and (c)), as consumers do not internalize the switching cost that they would incur in the future if they choose an inside good now and decide to switch to the other inside good later. This pattern changes when consumers are forward-looking when the

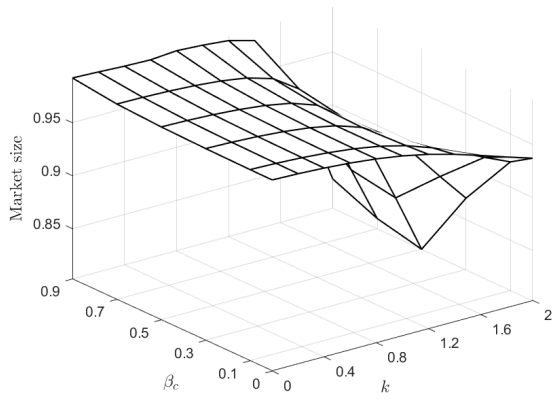

(a) market size, NR

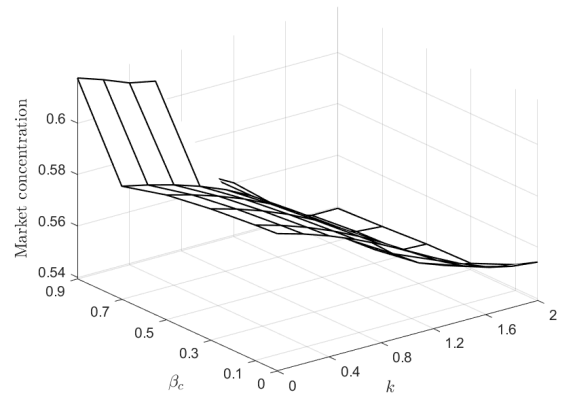

(b) market concentration, NR

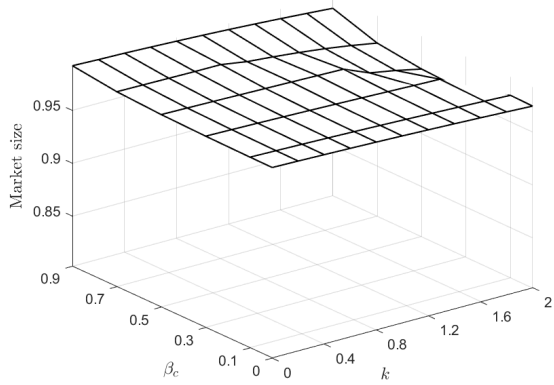

(c) market size, ER

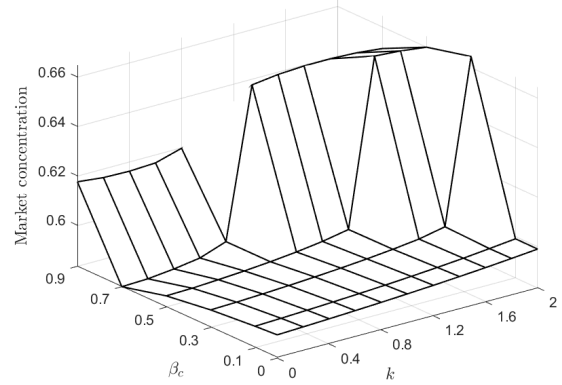

(d) market concentration, ER

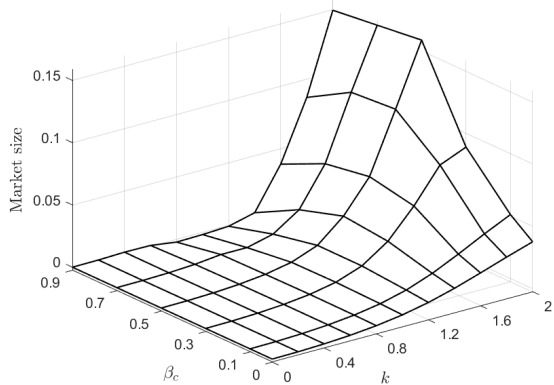

(e) market size, ER-NR

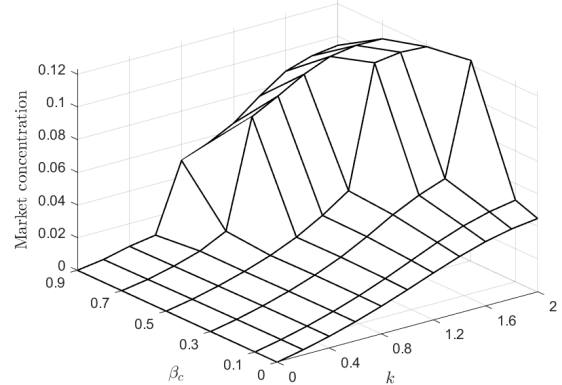

(f) market concentration, ER-NR

Figure 12: Market size and market concentration: forward-looking consumers. $v_0 = -5$, $M = 20$, $\theta = 0.4$. *NR*: No reimbursement. *ER*: Endogenous reimbursement.

reimbursement channel is disabled. In this case consumers take into consideration future switching costs, and as a result increases in k lower the attractiveness of the inside goods relative to the outside good, thereby increasing the outside good's market share and shrinking the market size. When the reimbursement channel is enabled, firms are able to reimburse consumers' switching costs, and as a result increases in k continue to have little impact on market size even when consumers are forward-looking ($\beta_c > 0$ in Panel (c)). Thus, the reimbursement channel results in a higher market size whenever $k > 0$. The difference in market size is particularly large when both β_c and k are large (Panel (e)).

Second, the right-column of panels shows that our previous findings regarding market concentration when consumers are myopic continue to hold when consumers are forward-looking: switching costs reduce market concentration when the reimbursement channel is disabled (Panel (b)) and increase market concentration with reimbursements (Panel (d)). The reimbursement channel results in a higher market concentration (Panel (f)). The difference in market concentration is particularly large when both β_c and k are large.

Third, forward-looking consumers internalize future network benefits that they would enjoy if they choose one of the inside goods (recall that the products are durable and consumers make purchasing decisions only when their existing products die). Therefore, consumers' forward-looking behavior amplifies network effects and tends to lead to a tipping equilibrium, especially when firms can reimburse. Without reimbursements (Panel (b)), a tipping equilibrium occurs when β_c is 0.9 and k is less than or equal to 0.6; further increases in k transition the equilibrium from tipping to splintered, a pattern that we saw previously in the case with myopic consumers and larger network effects. With reimbursements, when k is increased, there is a splintered equilibrium throughout for small values of β_c ($\beta_c = 0$ or 0.1) and there is a tipping equilibrium throughout when $\beta_c = 0.9$. For intermediate values of β_c , there is a splintered equilibrium at low switching costs, which is then changed to a tipping equilibrium at high switching costs as in the main analysis.

Note that if consumers are attentive in every period, then when $k = 0$, whether consumers are forward-looking or myopic won't make a difference, because when there are no switching costs, each consumer can costlessly re-optimize in every period, thus for forward-looking consumers, their dynamic decision problem boils down to a period-by-period optimization problem that has no inter-temporal linkages and is no different from the decision problem facing myopic consumers. However, in our model, consumers make decisions infrequently (they are attentive only when their existing products die), so consumers' forward-looking behavior (indexed by β_c) makes a difference even when $k = 0$, as can be seen most clearly in Panels (b) and (d) of Figure 12.

Additional results (not shown) show that our previous findings continue to hold in the new runs with forward-looking consumers: the larger firm reimburses a larger proportion of the switching cost than the smaller firm does, and firms' option to reimburse consumers' switching costs increases consumer surplus and total surplus while its effect on producer surplus is ambiguous.

7 Concluding Remarks

This paper develops a dynamic duopoly model of price competition with switching costs and network effects, where firms have the ability to reimburse consumers' switching costs. We use the model to investigate firms' pricing and reimbursement strategies and how competition and welfare are affected by these strategies. This setup yields several interesting and novel results.

When firms cannot reimburse consumers' switching costs, an increase in the switching cost causes a transition from a tipping equilibrium in which one firm dominates the market to a splintered equilibrium in which the firms split the market about evenly. Introducing the ability to reimburse switching costs benefits the larger firm and facilitates market tipping and winner-takes-most. A consequence is that the economy remains in a tipping equilibrium even at high switching costs. Even though the market is more concentrated, consumer welfare is higher than the case in which switching costs cannot be reimbursed. This finding has useful antitrust and consumer welfare policy implications, illustrating that in such industries, policy analysis relying heavily on the market concentration may be problematic.

In addition, we find that compared to the case without reimbursement, firms' option to reimburse switching costs increases consumer surplus and total surplus, and increases producer surplus when network effects are strong. Switching costs decrease consumer surplus if firms do not have the option to reimburse switching costs, but leave consumer surplus largely unchanged if firms have that option. These results demonstrate that the welfare outcome in the market critically depends on whether firms have the option to reimburse consumers' switching costs.

Lastly, we reiterate the caveat that in this paper, we have abstracted from some issues such as endogenous switching costs and endogenous product quality. Nonetheless, an unambiguous finding that emerges from our analysis is the important role that switching cost reimbursement plays in determining the market outcome including market concentration and consumer welfare, as well as the importance of taking such reimbursement into account when designing public policies. The model and results we have presented in this paper can hopefully serve as one benchmark and aid future research in this and related areas.

Incorporating endogenous switching costs in the analysis, which involves adding a third choice

variable of the firms besides price and reimbursement, is an interesting though challenging avenue for future research.

References

- Arie, Guy and Paul Grieco**, “Who pays for switching costs?,” *Quantitative Marketing and Economics*, 2014, 12 (4), 379–419.
- Barone, Guglielmo, Roberto Felici, and Marcello Pagnini**, “Switching costs in local credit markets,” *International Journal of Industrial Organization*, 2011, 29 (6), 694–704.
- Beggs, Alan and Paul Klemperer**, “Multi-period competition with switching costs,” *Econometrica*, 1992, 60 (3), 651–666.
- Benkard, C. Lanier**, “A dynamic analysis of the market for wide-bodied commercial aircraft,” *Review of Economic Studies*, 2004, 71 (3), 581–611.
- Bouckaert, Jan, Hans Degryse, and Thomas Provoost**, “Enhancing market power by reducing switching costs,” *Economics Letters*, 2012, 114 (3), 359–361.
- Budd, Christopher, Christopher Harris, and John Vickers**, “A model of the evolution of duopoly: Does the asymmetry between firms tend to increase or decrease?,” *Review of Economic Studies*, 1993, 60 (3), 543–573.
- Busse, Meghan R., Christopher R. Knittel, and Florian Zettelmeyer**, “Are consumers myopic? Evidence from new and used car purchases,” *American Economic Review*, 2013, 103 (1), 220–256.
- Cabral, Luís**, “Dynamic price competition with network effects,” *Review of Economic Studies*, 2011, 78 (1), 83–111.
- , “Dynamic pricing in customer markets with switching costs,” *Review of Economic Dynamics*, 2016, 20, 43–62.
- Casson, Tony and Patrick S. Ryan**, “Open Standards, Open Source Adoption in the Public Sector, and Their Relationship to Microsoft’s Market Dominance,” in Sherrie Bolin, ed., *Standards Edge: Unifier or Divider?*, Sheridan Books, 2006, pp. 87–99.
- Chen, Jiawei**, “How do switching costs affect market concentration and prices in network industries?,” *Journal of Industrial Economics*, 2016, 64 (2), 226–254.
- , “Switching costs and network compatibility,” *International Journal of Industrial Organization*, 2018, 58, 1–30.
- , **Susanna Esteban, and Matthew Shum**, “When do secondary markets harm firms?,” *American Economic Review*, 2013, 103 (7), 2911–34.
- , **Ulrich Doraszelski, and Joseph Harrington**, “Avoiding market dominance: Product compatibility in markets with network effects,” *RAND Journal of Economics*, 2009, 40 (3), 455–485.
- Chen, Pei-yu and Lorin M. Hitt**, *Handbook on Economics and Information Systems*, Vol. 1, Emerald,
- Chen, Yongmin**, “Paying customers to switch,” *Journal of Economics and Management Strategy*, 1997, 6 (4), 877–897.

- **and Robert Rosenthal**, “Dynamic duopoly with slowly changing customer loyalties,” *International Journal of Industrial Organization*, 1996, 14 (3), 269–296.
- Chen, Yuxin and Z. John Zhang**, “Dynamic targeted pricing with strategic consumers,” *International Journal of Industrial Organization*, 2009, 27 (1), 43–50.
- Ching, Andrew T.**, “A dynamic oligopoly structural model for the prescription drug market after patent expiration,” *International Economic Review*, 2010, 51 (4), 1175–1207.
- Choe, Chongwoo, Stephen King, and Noriaki Matsushima**, “Pricing with cookies: Behavior-based price discrimination and spatial competition,” *Management Science*, 2018, 64 (12), 5669–55687.
- Clements, Matthew and Hiroshi Ohashi**, “Indirect network effects and the product cycle: U.S. video games, 1994 - 2002,” *Journal of Industrial Economics*, 2005, 53 (4), 515–542.
- Colombo, Stefano**, “Imperfect behavior-based price discrimination,” *Journal of Economics and Management Strategy*, 2016, 25 (3), 563–583.
- , “Behavior- and characteristic-based price discrimination,” *Journal of Economics and Management Strategy*, 2018, 27 (2), 237–250.
- Cullen, Joseph and Oleksandr Shcherbakov**, “Measuring consumer switching costs in the wireless industry,” 2010. Working Paper.
- De Nijs, Romain**, “Behavior-based price discrimination and customer information sharing,” *International Journal of Industrial Organization*, 2017, 50, 319–334.
- Dell**, “Client installation services,” 2021. Retrieved March 16, 2021 from <https://www.dell.com/en-us/work/shop/clientinstallation/cp/clientinstallation>.
- Dick, Astrid A.**, “Demand estimation and consumer welfare in the banking industry,” *Journal of Banking & Finance*, 2008, 32 (8), 1661–1676.
- Doganoglu, Toker**, “Dynamic price competition with consumption externalities,” *Netnomics*, 2003, 5 (1), 43–69.
- **and Lukasz Grzybowski**, “Dynamic duopoly competition with switching costs and network externalities,” *Review of Network Economics*, 2013, 12 (1), 1–25.
- Doraszelski, Ulrich and Ariel Pakes**, “A framework for applied dynamic analysis in IO,” in Mark Armstrong and Robert H. Porter, eds., *Handbook of Industrial Organization*, Vol. 3, North Holland, 2007, chapter 30, pp. 1887–1966.
- **and Mark Satterthwaite**, “Computable Markov-perfect industry dynamics,” *RAND Journal of Economics*, 2010, 41 (2), 215–243.
- Dubé, Jean-Pierre, Gunter J. Hitsch, and Peter E. Rossi**, “Do switching costs make markets less competitive?,” *Journal of Marketing Research*, 2009, 46 (4), 435–445.
- Dubé, Jean Pierre, Gunter J. Hitsch, and Peter E. Rossi**, “State dependence and alternative explanations for consumer inertia,” *RAND Journal of Economics*, 2010, 41 (3), 417–445.
- ECAFSS**, “Competition issues in retail banking and payments systems markets in the EU,” 2006. European Competition Authorities Financial Services Subgroup.

- Ericson, Richard and Ariel Pakes**, “Markov-perfect industry dynamics: A framework for empirical work,” *Review of Economic Studies*, 1995, 62 (1), 53–82.
- Esteves, Rosa-Branca**, “Pricing with customer recognition,” *International Journal of Industrial Organization*, 2010, 28 (6), 669–681.
- , “Behavior-based price discrimination with retention offers,” *Information Economics and Policy*, 2014, 27, 39–51.
- Fabra, Natalie and Alfredo García**, “Dynamic price competition with switching costs,” *Dynamic Games and Applications*, 2015, 5 (4), 540–567.
- Farrell, Joseph and Paul Klemperer**, “Coordination and Lock-in: Competition with Switching Costs and Network Effects,” in Mark Armstrong and Robert H. Porter, eds., *Handbook of Industrial Organization*, Vol. 3, North Holland, 2007, chapter 31, pp. 1970–2056.
- Filson, Darren**, “A Markov-perfect equilibrium model of the impacts of price controls on the performance of the pharmaceutical industry,” *RAND Journal of Economics*, 2012, 43 (1), 110–138.
- Fudenberg, Drew and Jean Tirole**, “Customer poaching and brand switching,” *RAND Journal of Economics*, 2000, 31 (4), 634–657.
- Furman, Jason**, “Financial inclusion in the United States,” 2016. <https://obamawhitehouse.archives.gov/blog/2016/06/10/financial-inclusion-united-states>, accessed February 28, 2021.
- Gandal, Neil, Michael Kende, and Rafael Rob**, “The dynamics of technological adoption in hardware/software systems: The case of compact disc players,” *Rand Journal of Economics*, 2000, 31 (1), 43–61.
- Gehrig, Thomas, Oz Shy, and Rune Stenbacka**, “History-based price discrimination and entry in markets with switching costs: A welfare analysis,” *European Economic Review*, 2011, 55 (5), 732–739.
- , – , and – , “A welfare evaluation of history-based price discrimination,” *Journal of Industry, Competition and Trade*, 2012, 12, 373–393.
- German, Kent**, “FCC may limit early-termination fees,” 2008. <https://www.cnet.com/news/fcc-may-limit-early-termination-fees/>, accessed April 21, 2021.
- Goldman, David**, “Verizon will give you up to \$650 to switch,” 2015. <https://money.cnn.com/2015/12/29/technology/verizon-switch/index.html>, accessed February 16, 2019.
- Gowrisankaran, Gautam and Robert J. Town**, “Dynamic equilibrium in the hospital industry,” *Journal of Economics & Management Strategy*, 1997, 6 (1), 45–74.
- Handel, Benjamin R.**, “Adverse selection and inertia in health insurance markets: When nudging hurts,” *American Economic Review*, 2013, 103 (7), 2643–2682.
- Hortaçsu, Ali, Seyed Ali Madanizadeh, and Steven L. Puller**, “Power to choose? An analysis of consumer inertia in the residential electricity market,” *American Economic Journal: Economic Policy*, 2017, 9 (4), 192–226.

- Jing, Bing**, “Behavior-based pricing, production efficiency, and quality differentiation,” *Management Science*, 2017, *63* (7), 2365–2376.
- Keller, Timothy, David Miller, and Xiahua Wei**, “A steady-state approach to a network externality market with switching costs,” *NET Institute Working Paper #10-19*, September 2010, pp. 1–25.
- Klemperer, Paul**, “The competitiveness of markets with consumer switching costs,” *RAND Journal of Economics*, 1987, *18* (1), 138–150.
- , “Entry deterrence in markets with consumer switching costs,” *Economic Journal*, 1987, *97* (Supplement: Conference Papers), 99–117.
- , “Markets with consumer switching costs,” *Quarterly Journal of Economics*, 1987, *102* (2), 375–394.
- Markovich, Sarit**, “Snowball: A dynamic oligopoly model with indirect network effects,” *Journal of Economic Dynamics and Control*, 2008, *32* (3), 909–938.
- **and Johannes Moenius**, “Winning while losing: Competition dynamics in the presence of indirect network effects,” *International Journal of Industrial Organization*, 2009, *27* (3), 346–357.
- Mehra, Amit, Ram Bala, and Ramesh Sankaranarayanan**, “Competitive behavior-based price discrimination for software upgrades,” *Information Systems Research*, 2012, *23* (1), 60–74.
- Miao, Chun-Hui**, “Consumer myopia, standardization and aftermarket monopolization,” *European Economic Review*, 2010, *54* (7), 931–946.
- Mitchell, Matthew and Andrzej Skrzypacz**, “Network externalities and long-run market shares,” *Economic Theory*, 2006, *29* (3), 621–648.
- Pakes, Ariel and Paul McGuire**, “Computing Markov-perfect Nash equilibria: Numerical implications of a dynamic differentiated product model,” *RAND Journal of Economics*, 1994, *25* (4), 555–589.
- Park, Minjung**, “The economic impact of wireless number portability,” *Journal of Industrial Economics*, 2011, *59* (4), 714–745.
- Pazgal, Amit and David Soberman**, “Behavior-based discrimination: Is it a winning play, and if so, when?,” *Marketing Science*, 2008, *27* (6), 977–994.
- Ramasasthy, Anita**, “Web sites change prices based on customers’ habits,” 2005. <http://edition.cnn.com/2005/LAW/06/24/ramasasthy.website.prices/>, accessed April 21, 2021.
- Rhee, Ki-Eun and Raphael Thomadsen**, “Behavior-based pricing in vertically differentiated industries,” *Management Science*, 2017, *63* (8), 2729–2740.
- Rhodes, Andrew**, “Re-examining the effects of switching costs,” *Economic Theory*, 2014, *57* (1), 161–194.
- Schwab, Kristin**, “Walmart launching new service to compete with Amazon Prime,” 2020. <https://www.marketplace.org/2020/09/01/walmart-launching-service-compete-with-amazon-prime/>, accessed September 8, 2020.

- Shaffer, Greg and Z. John Zhang**, “Pay to switch or pay to stay: Preference-based price discrimination in markets with switching costs,” *Journal of Economics and Management Strategy*, 2000, 9 (3), 397–424.
- Shcherbakov, Oleksandr**, “Measuring consumer switching costs in the television industry,” *RAND Journal of Economics*, 2016, 47 (2), 363–393.
- Spectrum**, “Spectrum Contract Buyout. Switch and get up to \$500,” 2021. Retrieved March 16, 2021 from <https://www.spectrum.com/contract-buyout>.
- Stango, Victor**, “Pricing with consumer switching costs: Evidence from the credit card market,” *Journal of Industrial Economics*, 2002, 50 (4), 475–492.
- Strombom, Bruce, Thomas Buchmueller, and Paul Feldstein**, “Switching costs, price sensitivity and health plan choice,” *Journal of Health Economics*, 2002, 21 (1), 89–116.
- Suleymanova, Irina and Christian Wey**, “Bertrand competition in markets with network effects and switching costs,” *B.E. Journal of Economic Analysis & Policy*, 2011, 11 (1), Article 56.
- Swan, Peter**, “Optimum durability, second-hand markets, and planned obsolescence,” *Journal of Political Economy*, 1972, 80 (3), 575–585.
- Swann, G.M. Peter**, “The functional form of network effects,” *Information Economics and Policy*, 2002, 14 (3), 417–429.
- Tan, Wei**, “The effects of taxes and advertising restrictions on the market structure of the U.S. cigarette market,” *Review of Industrial Organization*, 2006, 28 (3), 231–251.
- Taylor, Curtis**, “Supplier surfing: Competition and consumer behavior in subscription markets,” *RAND Journal of Economics*, 2003, 34 (2), 223–246.
- Train, Kenneth E.**, *Discrete Choice Methods with Simulation*, second ed., Cambridge University Press, 2009.
- Viard, V. Brian**, “Do switching costs make markets more or less competitive? The case of 800-number portability,” *RAND Journal of Economics*, 2007, 38 (1), 146–163.
- Villas-Boas, J. Miguel**, “Dynamic competition with customer recognition,” *RAND Journal of Economics*, 1999, 30 (4), 604–631.
- , “A short survey on switching costs and dynamic competition,” *International Journal of Research in Marketing*, 2015, 32 (2), 219–222.
- von Weizsäcker, C. Christian**, “The costs of substitution,” *Econometrica*, 1984, 52 (5), 1085–1116.
- XConnect**, “Countries with mobile number portability,” 2021. Retrieved March 16, 2021, from <https://www.xconnect.net/countries-with-mobile-number-portability/>.
- Zhang, Juanjuan**, “The perils of behavior-based personalization,” *Marketing Science*, 2011, 30 (1), 170–186.

Online Appendix

A1 Figures from Main Analysis

This section offers seven figures that plot additional details from the main analysis. Figures A1-A4 each consist of six panels. Panel (a) of each figure plots firm 1's equilibrium pricing policy as a function of the state.^{A1} Panel (b) plots firm 1's equilibrium reimbursement strategy as a function of the state. Panel (c) plots the probability that a consumer switches from firm 1 to firm 2 as a function of the state. Panel (d) plots the resultant forces. Panel (e) plots that transient distribution of consumers after 15 periods and panel (f) plots the limiting distribution of consumers. Figures A1 and A2 plot the case in which the reimbursement channel is disabled for $k = 1$ and $k = 2$, respectively. Figures A3 and A4 plot the case in which the firms reimburse customers for $k = 1$ and $k = 2$, respectively.

Figures A5-A7 plot the market concentration, network benefits, average prices, consumer surplus, producer surplus, and total surplus for the cases in which the reimbursement channel is disabled, the reimbursement channel is enabled, and the difference in each value when the channel is enabled v. disabled. Each panel is plotted as a function of the network effect θ and the switching cost k for $\theta \in \{0, 0.5, \dots, 5\}$ and $k \in \{0, 0.25, \dots, 3\}$.

^{A1}Recall that the MPE is symmetric, so by permutating the state with respect to b_1 and b_2 , firm 2's pricing policy is found. This applies to panels (a)-(c) of all figures.

(a) Firm 1's price policy function

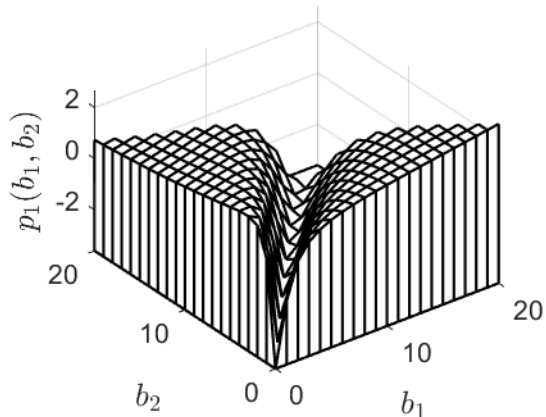

(b) Firm 1's reimbursement policy function

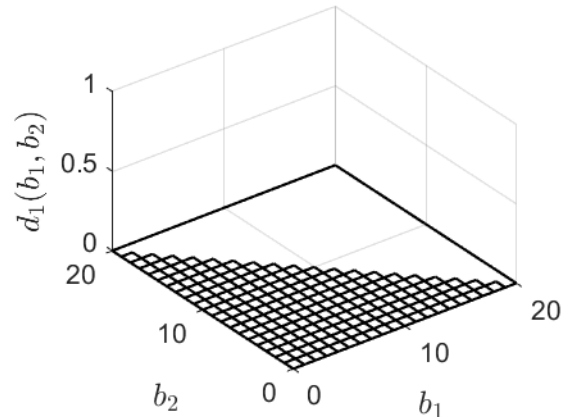

(c) Probability of a firm 1's customer switching to firm 2

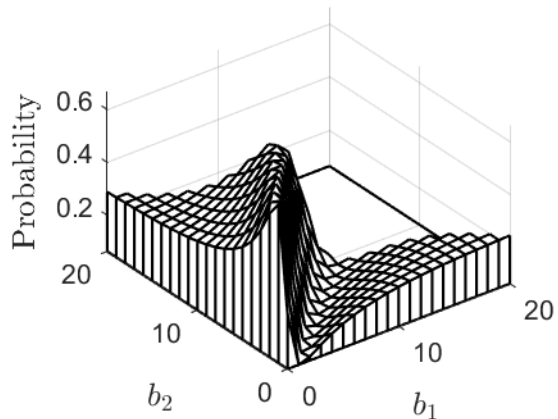

(d) Resultant forces

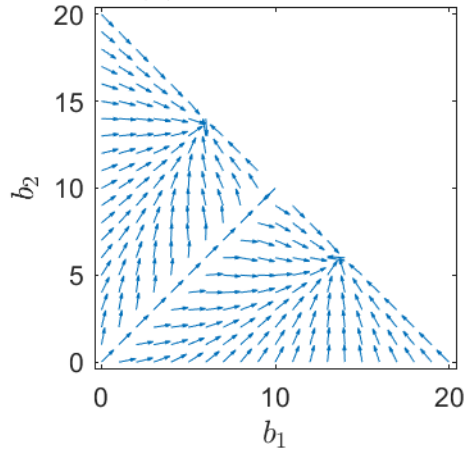

(e) Transient distribution after 15 periods

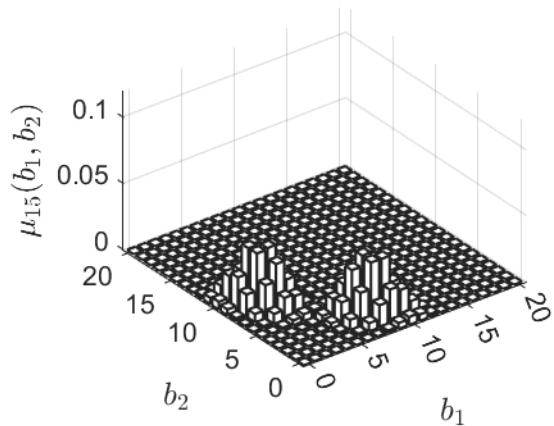

(f) Limiting distribution

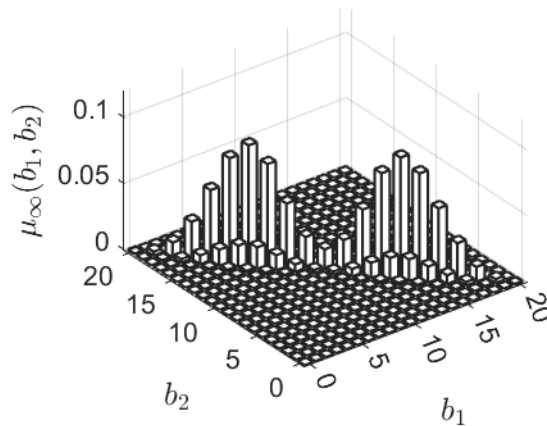

Figure A1. No reimbursement (NR): Tipping equilibrium at low switching cost.
 $v_0 = -5$, $M = 20$, $\theta = 2$, $k = 1$.

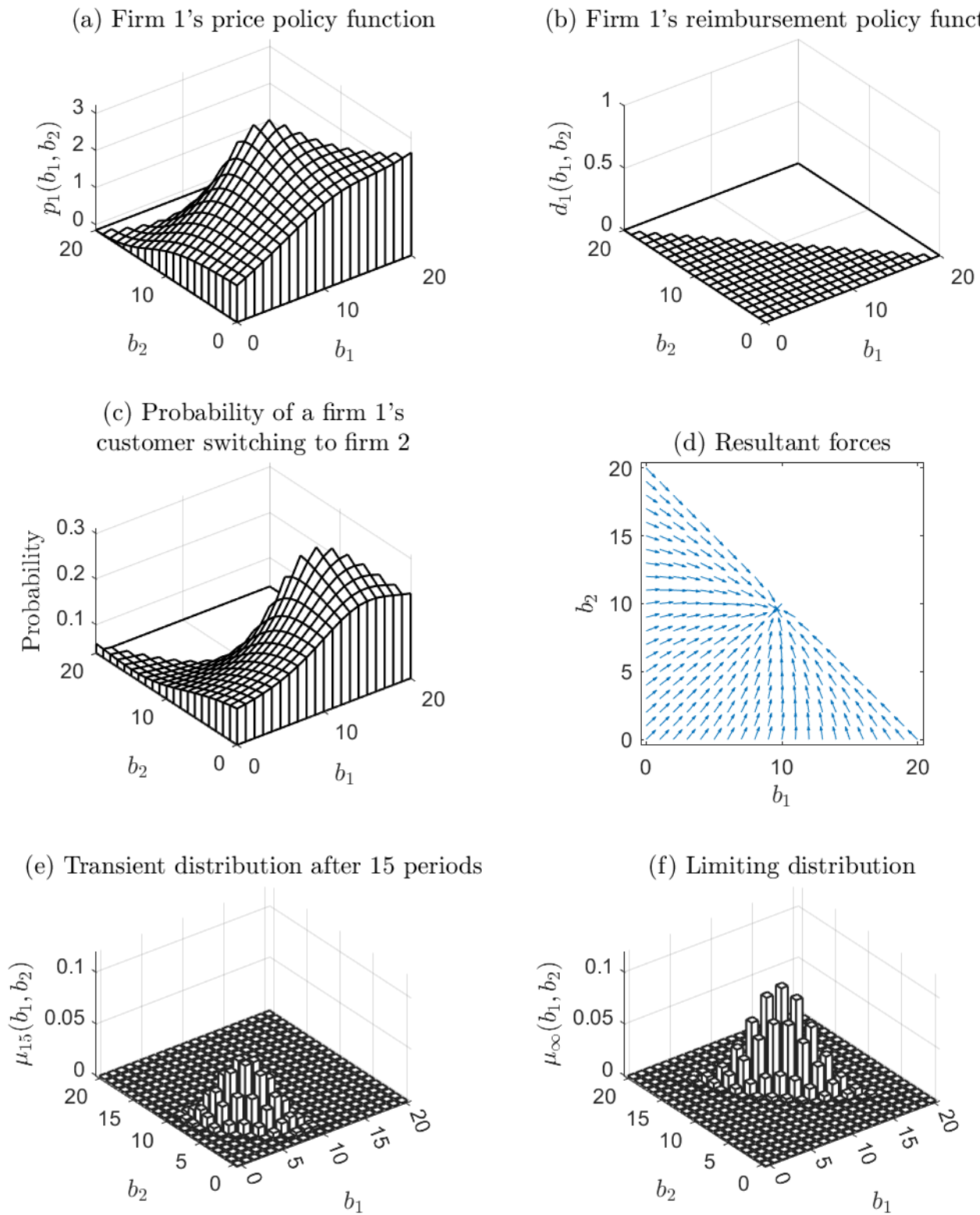
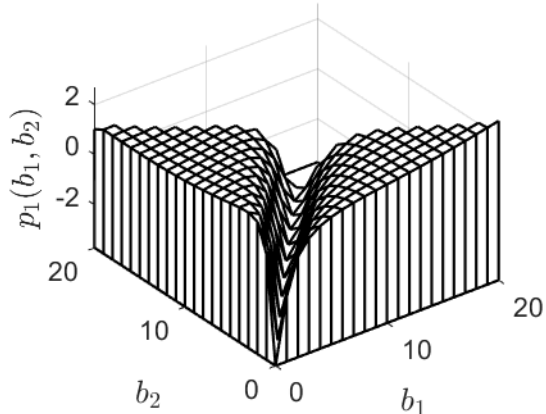
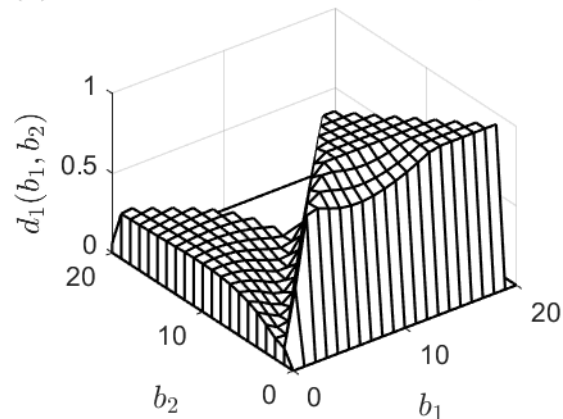

Figure A2. No reimbursement (NR): Splintered equilibrium at high switching cost.
 $v_0 = -5$, $M = 20$, $\theta = 2$, $k = 2$.

(a) Firm 1's price policy function



(b) Firm 1's reimbursement policy function



(c) Probability of a firm 1's customer switching to firm 2

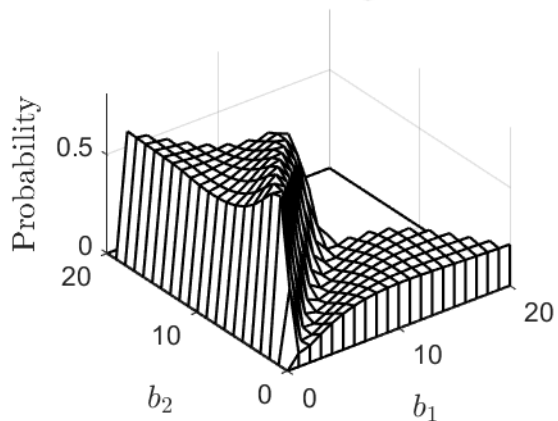

(d) Resultant forces

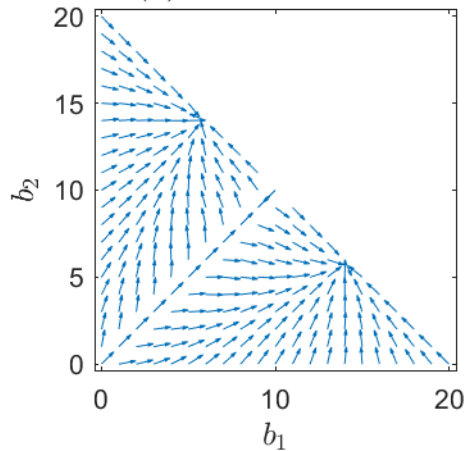

(e) Transient distribution after 15 periods

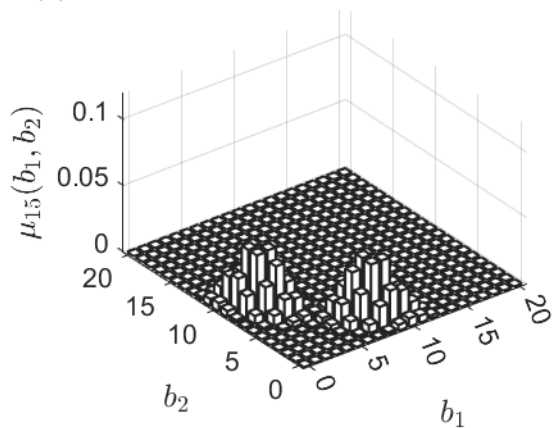

(f) Limiting distribution

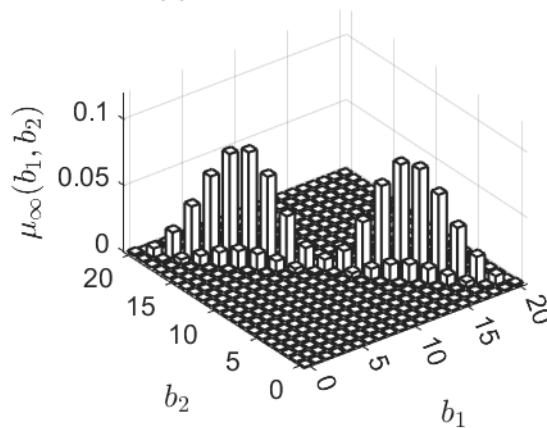
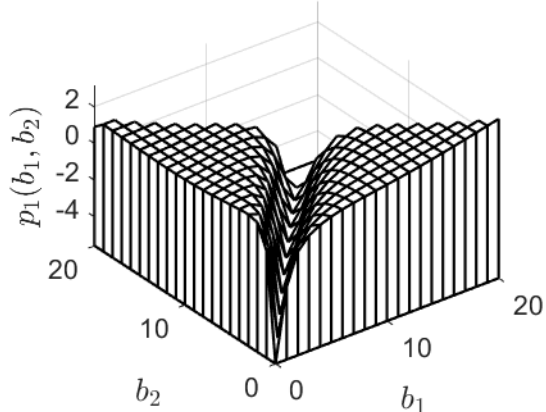
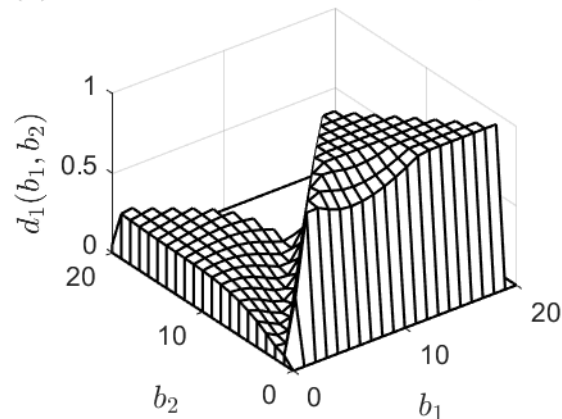

Figure A3. Endogenous reimbursement (ER): Tipping equilibrium at low switching cost.
 $v_0 = -5$, $M = 20$, $\theta = 2$, $k = 1$.

(a) Firm 1's price policy function



(b) Firm 1's reimbursement policy function



(c) Probability of a firm 1's customer switching to firm 2

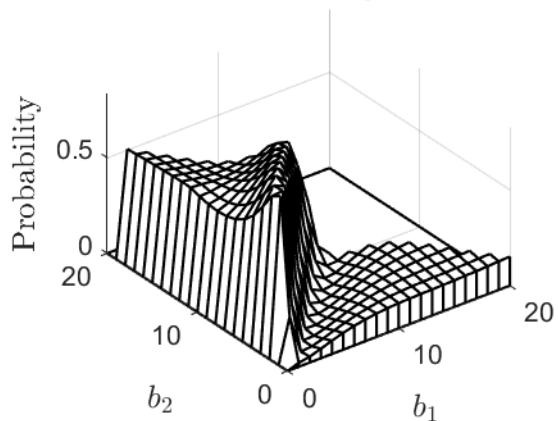

(d) Resultant forces

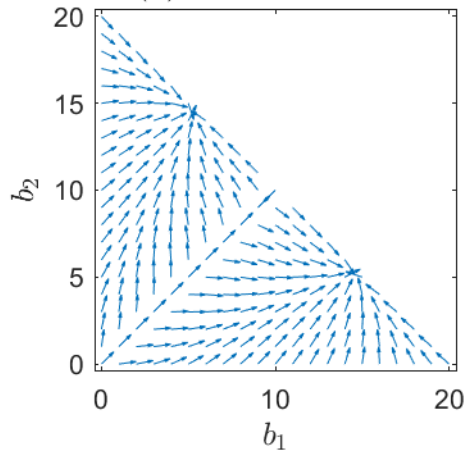

(e) Transient distribution after 15 periods

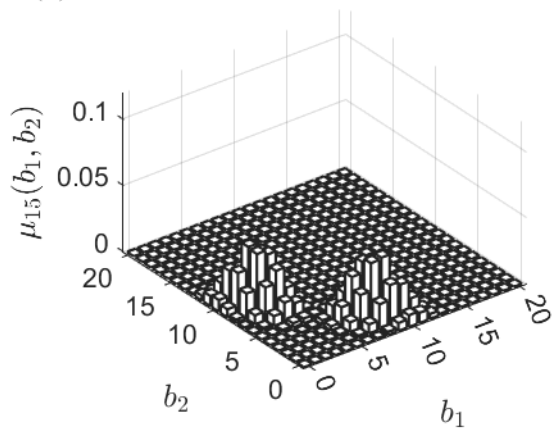

(f) Limiting distribution

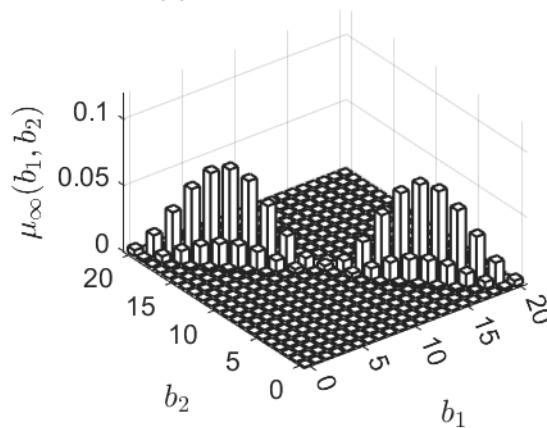

Figure A4. Endogenous reimbursement (ER): Tipping equilibrium at high switching cost.
 $v_0 = -5$, $M = 20$, $\theta = 2$, $k = 2$.

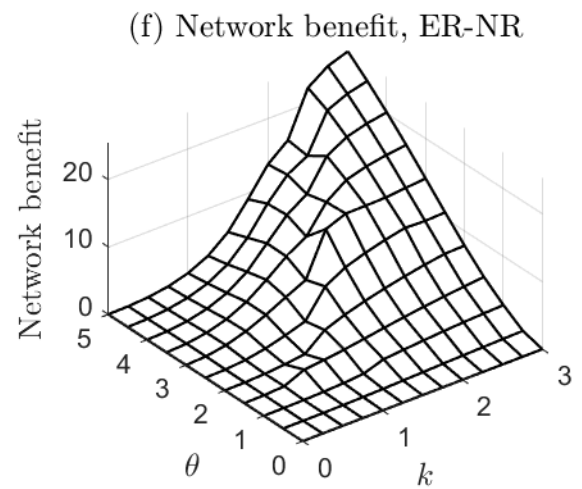
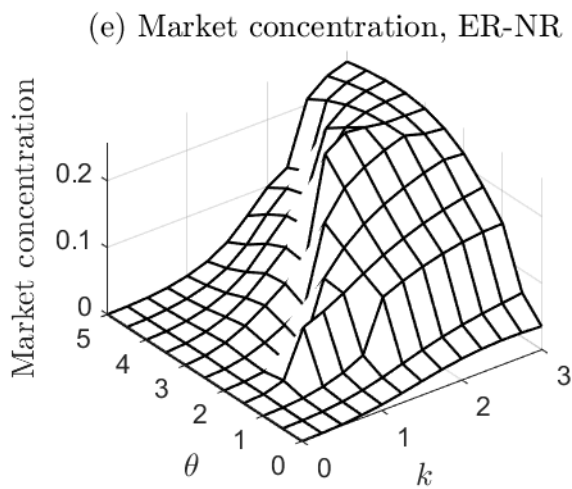
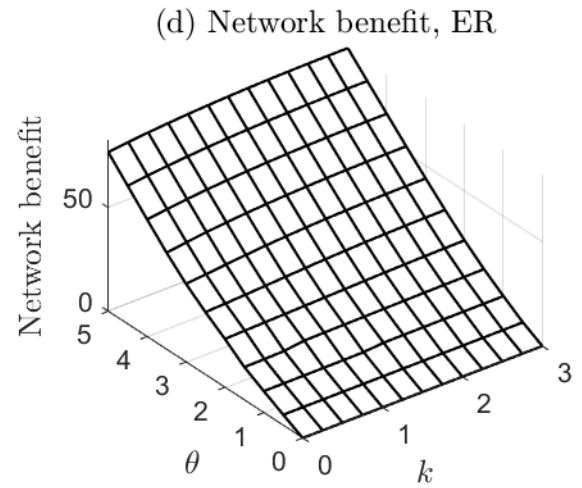
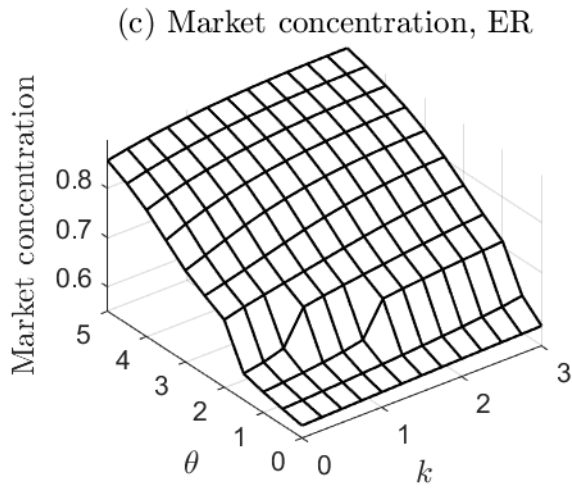
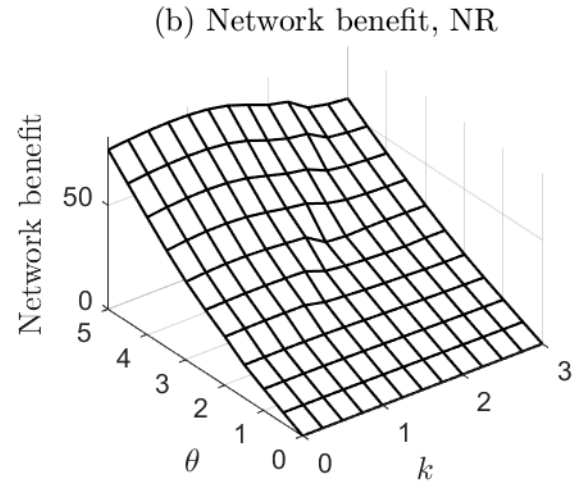
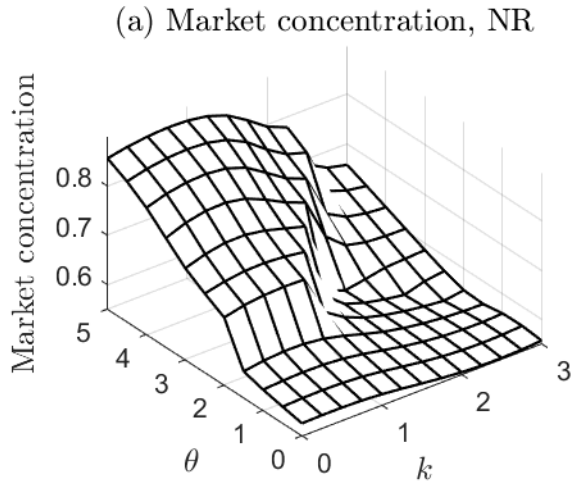

Figure A5. Market concentration and network benefit. $v_0 = -5$, $M = 20$.
 NR: No reimbursement. ER: Endogenous reimbursement.

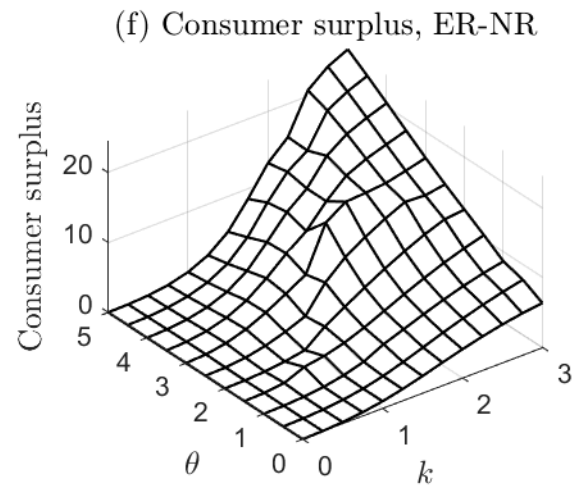
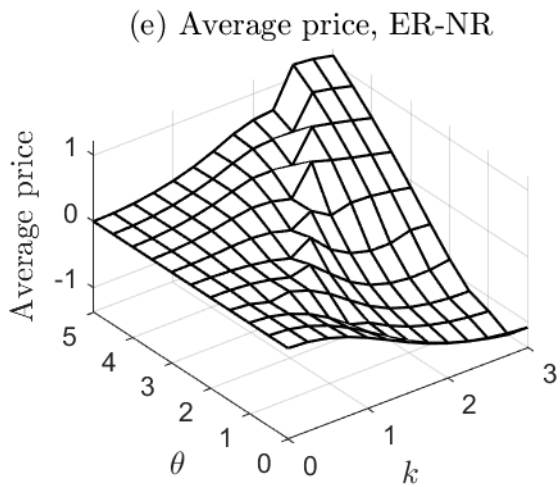
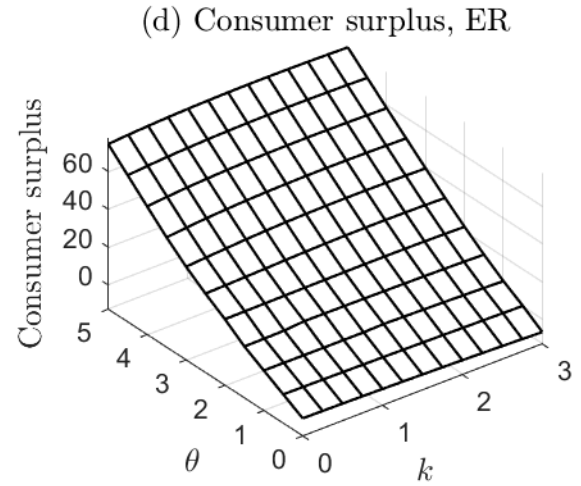
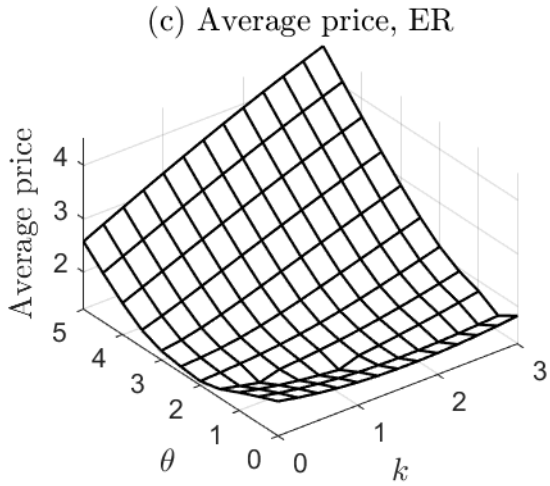
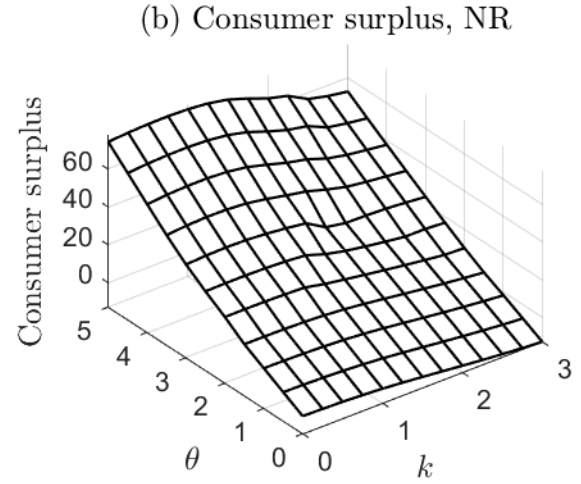
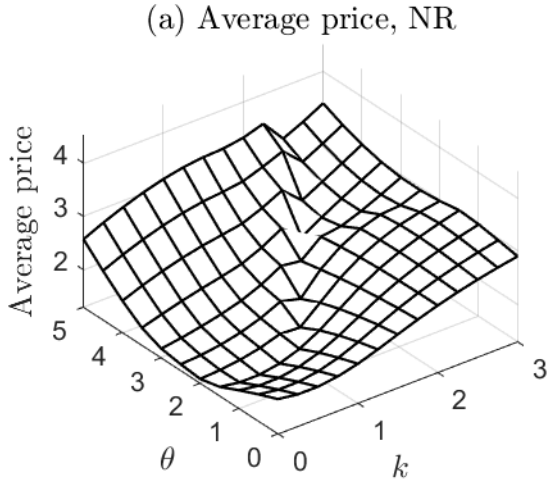

Figure A6. Average price and consumer surplus. $v_0 = -5$, $M = 20$.
 NR: No reimbursement. ER: Endogenous reimbursement.

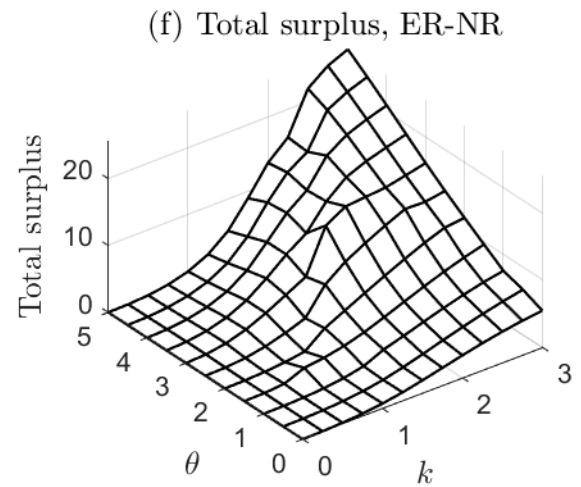
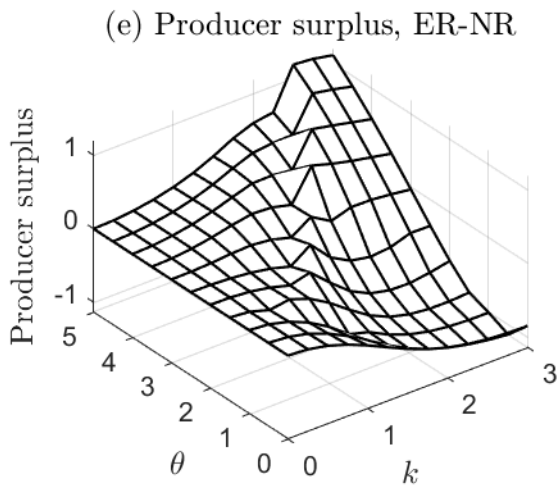
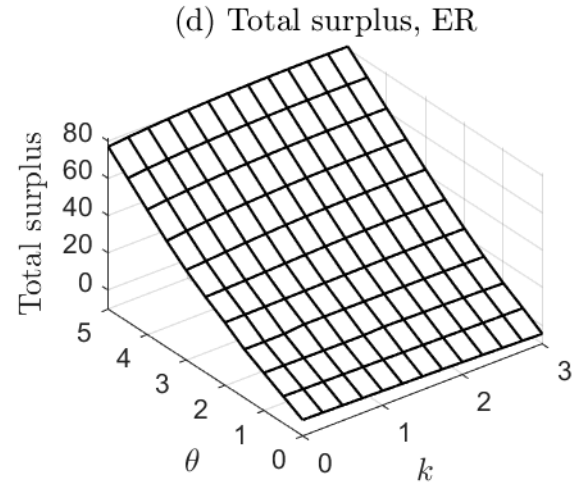
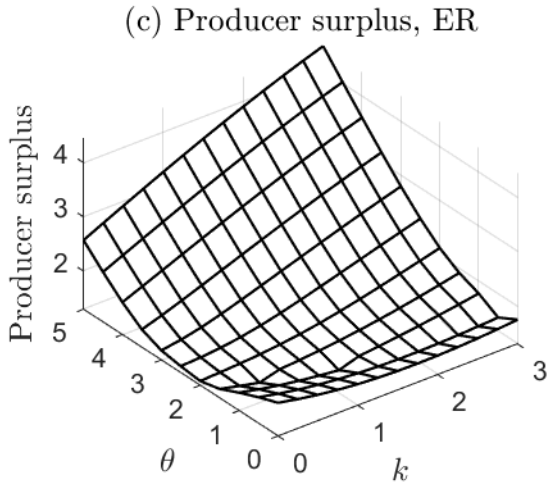
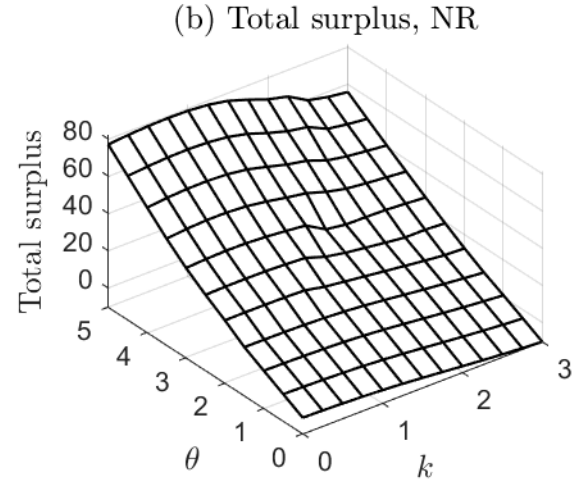
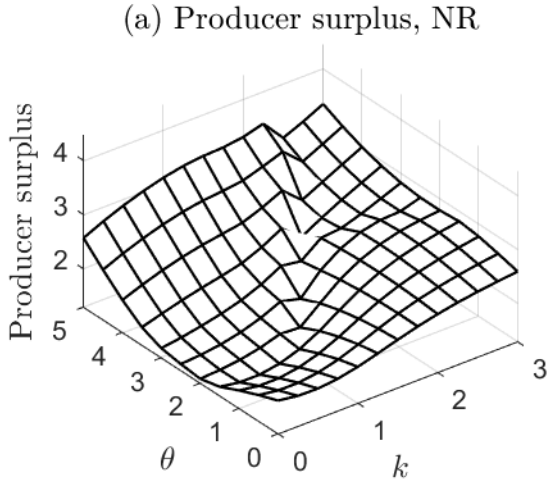

Figure A7. Producer surplus and total surplus. $v_0 = -5$, $M = 20$.
 NR: No reimbursement. ER: Endogenous reimbursement.

A2 A Model with Forward-Looking Consumers

In this appendix, we modify the main model in Section 2 to incorporate forward-looking consumers. In what follows, we will use $i \in \{1, 2, \dots, M\}$ to index consumers, and use $j \in \{0, 1, 2\}$ to index goods and firms.

A2.1 Consumers' Problem

Let $r_i \in \{0, 1, 2\}$ denote the good that consumer i has at the beginning of the period. Below we will use superscript 0 to indicate expressions for an inattentive consumer, and use superscript 1 to indicate expressions for an attentive consumer.

Single-Period Utility Consumer i 's single-period utility when she is inattentive is

$$u^0(b, r_i, \epsilon_i) = v_{r_i} + \mathbf{1}(r_i \neq 0)\theta g(b_{r_i}) + \epsilon_{i, r_i}, \quad (\text{A1})$$

and her single-period utility when she is attentive and chooses to purchase good j is

$$u^1(b, p, d, r_i, \epsilon_i, j) = v_j + \mathbf{1}(j \neq 0)\theta g(b_j) - p_j - \mathbf{1}(r_i \neq 0, j \neq 0, r_i \neq j)(1 - d_j)k + \epsilon_{ij}. \quad (\text{A2})$$

The definitions of the variables in Eqs. (A1) and (A2) are the same as those in the main model, described in Subsection 2.2.

Bellman Equation Let $W(\cdot)$ denote consumer i 's value function at the beginning of a period before knowing whether her product unit dies in that period. Her Bellman equation is

$$W(b, p, d, r_i, \epsilon_i) = \left(1 - \frac{1}{M}\right)W^0(b, p, d, r_i, \epsilon_i) + \frac{1}{M}W^1(b, p, d, r_i, \epsilon_i), \quad (\text{A3})$$

where $W^0(b, p, d, r_i, \epsilon_i)$ is consumer i 's value if her product unit does not die and she is therefore inattentive in this period:

$$W^0(b, p, d, r_i, \epsilon_i) = u^0(b, r_i, \epsilon_i) + \beta_c \mathbb{E}_{b', \epsilon'_i} [W(b', P(b'), D(b'), r_i, \epsilon'_i)], \quad (\text{A4})$$

and $W^1(b, p, d, r_i, \epsilon_i)$ is consumer i 's value if her product unit dies and she is therefore attentive in this period:

$$W^1(b, p, d, r_i, \epsilon_i) = \max_{j \in \{0, 1, 2\}} \left\{ u^1(b, p, d, r_i, \epsilon_i, j) + \beta_c \mathbb{E}_{\epsilon'_i} [W(b', P(b'), D(b'), j, \epsilon'_i)] \right\}. \quad (\text{A5})$$

In the above expressions for the consumer's value function, $\beta_c \in [0, 1)$ is the consumers' discount factor, $P(\cdot) = (P_1(\cdot), P_2(\cdot))$ and $D(\cdot) = (D_1(\cdot), D_2(\cdot))$ denote the two firms' price and reimbursement policy functions, respectively, $b' = (b'_1, b'_2)$ is the next-period industry state, and $\epsilon'_i = (\epsilon'_{i0}, \epsilon'_{i1}, \epsilon'_{i2})$ is consumer i 's next-period idiosyncratic preference shocks. The expectation on the right-hand side of Eq. (A4) is taken over both b' and ϵ'_i , where the expectation of b' is based on the probabilities of the attentive consumer's loyalty (Eq. (1)) and her choice probabilities (Eq. (A10) below). In comparison, the expectation on the right-hand side of Eq. (A5) is taken over ϵ'_i only, as in that equation b' is pinned down given b , r_i , and j ; see the state transition function Eq. (A11) below.

Note that the Bellman equation in Eq. (A3) involves the stochastic ϵ_i and therefore cannot be directly used for value function iteration. Let $\tilde{W}(b, p, d, r_i) = \mathbb{E}_{\epsilon_i} W(b, p, d, r_i, \epsilon_i)$ denote consumer

i 's expected value function where the expectation is taken over ϵ_i . We can then take the expectation of both sides of Eq. (A3) with respect to ϵ_i to obtain the consumer's Bellman equation in expected value function:

$$\tilde{W}(b, p, d, r_i) = \left(1 - \frac{1}{M}\right) \tilde{W}^0(b, p, d, r_i) + \frac{1}{M} \tilde{W}^1(b, p, d, r_i), \quad (\text{A6})$$

where

$$\tilde{W}^0(b, p, d, r_i) = \tilde{u}^0(b, r_i) + \beta_c \mathbb{E}_{b'} \left[\tilde{W}(b', P(b'), D(b'), r_i) \right] \quad (\text{A7})$$

and

$$\tilde{W}^1(b, p, d, r_i) = \log \left[\sum_{j=0}^2 \exp \left\{ \tilde{u}^1(b, p, d, r_i, j) + \beta_c \tilde{W}(b', P(b'), D(b'), j) \right\} \right]. \quad (\text{A8})$$

In the above, $\tilde{u}^0(\cdot)$ and $\tilde{u}^1(\cdot)$ denote the deterministic part of $u^0(\cdot)$ and $u^1(\cdot)$, respectively, the mean of ϵ_i is normalized to 0, and Eq. (A8) is obtained using the property of logit demand that the expected value of the best choice among a set of choices is the so-called *log-sum term* (Train (2009, p. 56)).

The consumer's Bellman equation in expected value function does not involve the stochastic ϵ_i and is used in the value function iteration in our algorithm to solve for the dynamic equilibrium.

Choice Probabilities of the Attentive Consumer Consider the attentive consumer in the current period, consumer a , whose original product r_a dies and who returns to the market to make a purchasing decision. Let

$$\psi(b, p, d, r_a, j) = \tilde{u}^1(b, p, d, r_a, j) + \beta_c \tilde{W}(b', P(b'), D(b'), j) \quad (\text{A9})$$

denote this consumer's expected value associated with choosing good j . In the above expression, the next-period industry state b' is pinned down given b , r_a , and j ; see the state transition function Eq. (A11) below. Using the logit choice probability formula, we can write the probability that this consumer chooses good j as

$$\phi(b, p, d, r_a, j) = \frac{\exp[\psi(b, p, d, r_a, j)]}{\sum_{h=0}^2 \exp[\psi(b, p, d, r_a, h)]}. \quad (\text{A10})$$

State Transition Given our assumption that in every period, one random consumer out of the M consumers experiences product death and becomes attentive, the probability distribution of r_a —the attentive consumer's original product—is given by $\Pr(r_a = j|b) = b_j/M$, for $j = 0, 1, 2$.

Let $s_a \in \{0, 1, 2\}$ denote the attentive consumer's product choice. The industry state then transitions based on the joint outcome of the installed base depreciation (product death) and the attentive consumer's purchasing decision:

$$b' = B(b, r_a, s_a) = \underbrace{(b_1 - \mathbf{1}(r_a = 1) + \mathbf{1}(s_a = 1))}_{b'_1}, \underbrace{(b_2 - \mathbf{1}(r_a = 2) + \mathbf{1}(s_a = 2))}_{b'_2}. \quad (\text{A11})$$

A2.2 Firms' Problem

Firm j chooses its price p_j and reimbursement d_j in each period. Let $V_j(b)$ denote the expected net present value of current-period and future cash flows to firm j in state b . Firm j 's Bellman equation is given by

$$V_j(b) = \max_{p_j, d_j} \mathbb{E}_{r_a} \left[\phi(b, (p_j, P_{-j}(b)), (d_j, D_{-j}(b)), r_a, j) (p_j - \mathbf{1}(r_a \neq 0, r_a \neq j) d_j k) \right. \\ \left. + \beta \sum_{h=0}^2 \phi(b, (p_j, P_{-j}(b)), (d_j, D_{-j}(b)), r_a, h) V_j(b') \right], \quad (\text{A12})$$

where $\beta \in [0, 1)$ is the firms' discount factor, the (constant) marginal cost of production is normalized to zero, $P_{-j}(b)$ is the equilibrium price charged by firm j 's rival, $D_{-j}(b)$ is the equilibrium proportion of the switching cost reimbursed by firm j 's rival, and the next-period industry state b' at the end of the equation is $b' = B(b, r_a, h)$ according to the state transition function Eq. (A11).

A2.3 Equilibrium

In equilibrium, from consumers' point of view, both p and d are functions of the industry state b based on the firms' equilibrium price and reimbursement policy functions: $p = P(b) = (P_1(b), P_2(b))$ and $d = D(b) = (D_1(b), D_2(b))$. Therefore, we can rewrite consumers' expected value function $\tilde{W}(b, p, d, r_i)$ as a function of b and r_i only, by substituting p and d with $P(b)$ and $D(b)$, respectively. Consequently, consumers' Bellman equation Eq. (A6) can be rewritten as an equation that involves only two variables, b and r_i :

$$\tilde{W}(b, r_i) = \left(1 - \frac{1}{M}\right) \left\{ \tilde{u}^0(b, r_i) + \beta_c \mathbb{E}_{b'} \left[\tilde{W}(b', r_i) \right] \right\} \\ + \frac{1}{M} \log \left[\sum_{j=0}^2 \exp \left\{ \tilde{u}^1(b, P(b), D(b), r_i, j) + \beta_c \tilde{W}(B(b, r_i, j), j) \right\} \right]. \quad (\text{A13})$$

The Markov perfect equilibrium of the infinite-horizon dynamic game described above consists of the following equilibrium functions: the firms' price and reimbursement policy functions $P_j(b)$ and $D_j(b)$, the firms' value function $V_j(b)$, and the consumers' expected value function $\tilde{W}(b, r_i)$, $r_i = 0, 1, 2$. In equilibrium, those functions jointly satisfy the following conditions for every industry state b :

1. $(P_j(b), D_j(b))$ is the solution to firm j 's maximization problem on the right-hand side of Eq. (A12).
2. $V_j(b)$ satisfies the recursive equation in Eq. (A12).
3. $\tilde{W}(b, r_i)$, $r_i = 0, 1, 2$ satisfies the recursive equation in Eq. (A13).

We use value function iteration based on the above conditions to solve for the Markov perfect equilibrium.